

Water Quality Monitoring System W-20XD Series



1 month continuous monitoring

13 simultaneous parameters

Depth up to 100 meters

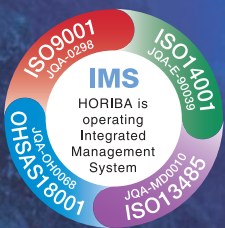

CE marking compliant

Measurement data is stored in the sensor probe offering the convenience to deploy the sensor probe without cable and control unit for continuous monitoring.

Selection of a cable and ion sensors are necessary to complete a multi-probe system.

- Up to one month
Data logging
- Simultaneous measurement of
13 parameters
- Measurement at depths as low as
100 meters

This system is optimal for assessment and testing of the water quality of sea water, river water, dams, well water, ground water, city water, storm water run-off, lakes, ponds, and fish farms. Horiba's sensor design, which has been developed over the course of many years, is housed in a 47mm diameter sensor probe. Horiba's sensor advances broaden application options in pressurized conditions and continuous monitoring while offering high precision and simultaneous measurement of as many as 13 parameters. The system is compatible with GPS and data retrieval options to process and manage data on a personal computer. Continuous monitoring is possible for one month deploying the sensor probe at the site to collect data at 15 minute intervals.

Control Unit



W-2000S
Control Unit, Grip holder, Battery

Cables



W-002CS 2m
W-010CS 10m
W-030CS 30m
W-060CS 60m
W-100CS 100m

Multi-Probe

Sensor probe with built-in sensors (depth, conductivity, temperature, turbidity)

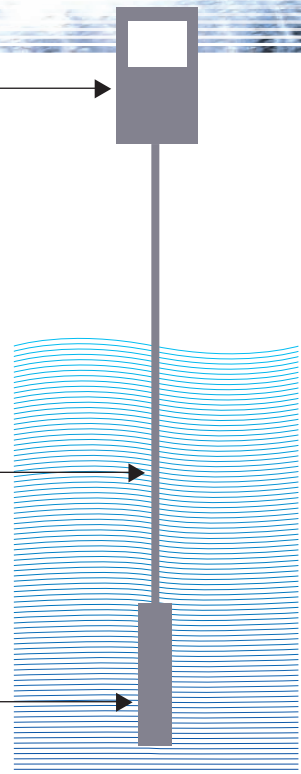

● **W-22XD sensor**

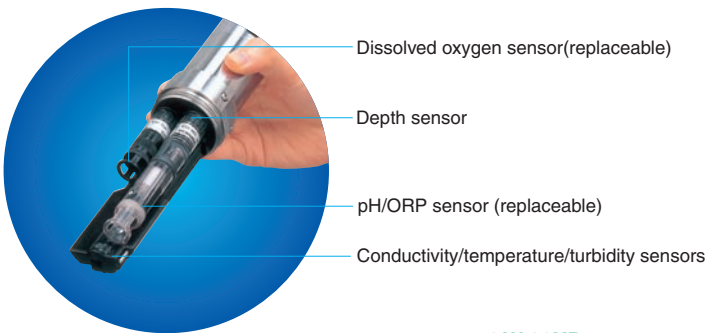

● **W-23XD sensor**

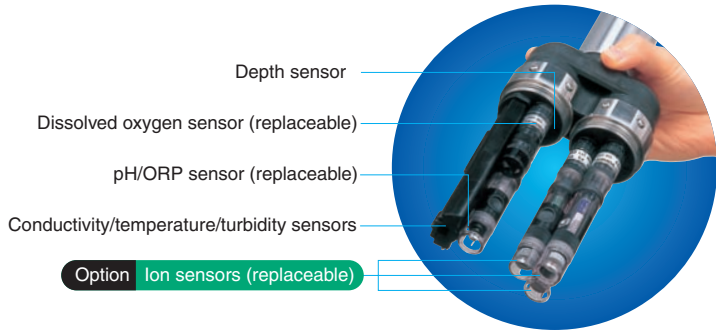

W-22XD

Packing List
pH4 standard solution, Reference solution, Calibration beaker, Batteries, Instruction manual, Consumables









W-23XD

Packing List
pH4 standard solution, Reference solution, Ion auto-cal solution, Calibration beaker, Batteries, Instruction manual, Consumables

W-20XD series measurement parameters	W-22XD	W-23XD
Maximum probe size	47mm	97mm
pH	●	●
Dissolved oxygen	●	●
Conductivity	●	●
Salinity	●	●
Total dissolved solids (TDS)	●	●
Seawater specific gravity	●	●
Temperature	●	●
Turbidity	●	●
Depth	●	●
Oxidation reduction potential (ORP)	●	●
Data logging	●	●
100m depth mess.		●
Nitrate ion*		●
Calcium ion*		●
Chloride ion*		●
Fluoride ion*		●
Potassium ion*		●
Ammonia*		●

*Optional sensor (replacement with other ion sensors is possible).
●option
6 ion options for the 3 available ports

W-20XD series

Item	Model	Code
Sensor Probe Standard Accessories:DO·Temperature·Conductivity·Water depth sensors, pH4 Standard solution Option sensor:pH or pH/ORP·DO sensor	W-22XD	3014020376
	W-23XD	3014020378
Cable	2m	W-002CS 3014007910
	10m	W-010CS 3014007912
	30m	W-030CS 3014007914
	60m	W-060CS* 3014022058
	100m	W-100CS* 3014007916
Control Unit	W-2000S	3014007930
Sensor         	pH sensor ★	6230 3014050849 (9037005600)
	pH/ORP sensor ★	6280 3014050850 (9037005700)
	DO sensor ★	5460 3014001152 (9037005800)
	Nitrate ion sensor ★	6531 3014050863 (9037005900)*
	Chloride ion sensor ★	6522 3014050860 (9037006000)*
	Calcium ion sensor ★	6533 3014050861 (9037006100)*
	Fluoride ion sensor ★	6530 3014050859 (9037006300)*
	Potassium ion sensor ★	6532 3014050862 (9037006400)*
	Ammonia sensor ★	5012 3014050864 (9037006200)

★ A cartridge for ion sensor replacement and reference internal solution are also included in the ion sensor.
*Please inquire separately about the delivery date about the production on orders.
* includes replacement chips for the ion sensors

Option

Item	Model	Code
Replacement chips for the ion sensors ※not include the ion sensors.	Nitrate ion cartridge	7681 3014068364 (9003015200)
	Chloride ion cartridge	8660 3014093436 (9003015000)
	Calcium ion cartridge	7683 3014068795 (9003015400)
	Potassium ion cartridge	7682 3014069795 (9003015300)
	Fluoride ion cartridge	7661 3014093438 (9003015100)
	Ammonia membrane	NH ₃ membrane 3014001155 (9037007000)
	DO membrane replacement kit	DO membrane 3014050853 (9037007400)
Extension adaptor	U-2001	3014001085
Carring case	W-2030	3014007945
Flow cell	W-2100	3014007978
Probe guard	W-2200*	3014007980
Communication cable	RS-232C	3200043675 (9037007500)
AC adaptor	AC-10	3200044196
Inner fluid	Ion one-point standard solution, 250mL	130 3014001154 (9037006500)
	Nitrate ion sensor reference internal solution, 50mL	302 3014001273 (9037006600)
	Chloride ion sensor reference internal solution, 50mL	301 3014001271 (9037006700)
	Calcium and fluoride ion sensor reference internal solution, 250mL	300 3200043640 (9003003200)
	Potassium ion sensor reference internal solution, 50mL	303 3014001272 (9037006900)
	Ammonia sensor reference internal solution, 50mL	370 3014067184 (9012000900)

*Please inquire separately about the delivery date about the production on orders.

Standard solution

Item	Model	Code
Standard Solution 	pH4 (for automatic calibration), 500mL	100-4 3200043638 (9003001600)
	pH4 (for automatic calibration), 4 L	140-4 3200174430
	pH7 500 mL	100-7 3200043637 (9003001700)
	pH9 500 mL	100-9 3200043636 (9003001800)
	ORP standard solution powder For 250 mLx10	160-51 3200043618 (9003003100)
	ORP standard solution powder For 250 mLx10	160-22 3200043617 (9003003000)
Internal fluid	Internal fluid for pH reference 250 mL	330 3200043641 (9037005200)

W-20XD series specifications

Control Unit	Water proof construction	IP-67	●	●	
Multi-Probe *1	Measurement temperature	0~55°C	●	●	
	Storage temperature	-5~60°C			
	Measurement depth *2	to 100 m			
	Maximum probe size	95 mm			
	Probe length	430 mm	●	●	
	Continuous use *3	30days			
	Data logging	○			
	Manual data memory (2880 items)	○			
Automatic calibration	○				
pH ●Two-point calibration ●Automatic temperature compensation	Measurement Principle	Glass electrode method			
	Range	pH 0~14	●	●	
	Resolution	0.01 pH			
	Repeatability	±0.05 pH			
Accuracy	±0.1 pH				
Dissolved oxygen ●Salt correction (0 to 40 ppt/automatic) ●Automatic temperature compensation	Measurement Principle	Diaphragm galvanic battery method			
	Range	0~19.99 mg/L	●	●	
	Resolution	0.01 mg/L			
	Repeatability	±0.1 mg/L			
Accuracy	±0.2 mg/L				
Conductivity ●Auto range ●Automatic temperature conversion (25°C) ●SI units	Measurement Principle	4 AC electrode method			
	Range	0~9.99 S/m	●	●	
	Resolution	0.1%F.S.			
	Repeatability	±1%			
Accuracy	±3%				
Salinity	Measurement Principle	Conductivity conversion			
	Range	0~4%	●	●	
	Resolution	0.01%			
	Repeatability	±0.1%			
Accuracy	±0.3%				
Total Dissolved Solids (TDS) ●Conversion factor setting	Measurement Principle	Conductivity conversion			
	Range	0~100 g/L	●	●	
	Resolution	0.1%F.S.			
	Repeatability	±2 g/L			
Accuracy	±5 g/L				
Seawater specific gravity ●Display σ _t , σ ₀ , σ ₁₅	Measurement Principle	Conductivity conversion			
	Range	0~50 σ _t	●	●	
	Resolution	0.1 σ _t			
	Repeatability	±2 σ _t			
Accuracy	±5 σ _t				
Temperature	Measurement Principle	Thermistor method			
	Range	0~55°C	●	●	
	Resolution	0.01°C			
	Repeatability	±0.3°C			
	Accuracy	±1.0°C			
Turbidity ●Unit selection	Measurement Principle	Penetration and scattering method			
	Range	0~800 NTU	●	●	
	Resolution	0.1 NTU			
	Repeatability	±3%			
Accuracy	±5%				
Water depth	Measurement Principle	Pressure method			
	Range(NTU or mg/L)	0~100m	●	●	
	Resolution	0.1 m			
	Repeatability	±3%			
	Accuracy	±5%			
Oxidation reduction potential(ORP)	Measurement Principle	Platinum electrode method			
	Range	1999 mV	●	●	
	Resolution	1 mV			
	Repeatability	±5 mV			
Accuracy	±15 mV				
Ion ●Auto range	Measurement Principle	Ion electrode method			
	Resolution	0.1%F.S.			
	Repeatability	±5%			
	Accuracy	±10%			
	Nitric acid ion Chloride ion Calcium ion Fluoride ion Potassium ion Ammonia	Range	NO ₃ : 0.62~62,000 mg/L(pH 3~7) Cl ⁻ : 0.4~35,000 mg/L(pH 3~11) Ca ²⁺ : 0.4~40,080 mg/L(pH 5~11) F ⁻ : 0.02~19,000 mg/L(pH4~10:20 mg/L) K ⁺ : 0.04~39,000 mg/L(pH5~11:3.9 mg/L) NH ₃ : 0.1~1,000 mg/L(pH 12 or more)	●	
		Simultaneously measurable parameters		10	13

(●)Option

Note:The accuracy rating value is obtained from measurements at an intermediate point of the standard solution after two-point calibration (at room temperature and pressure).
The repeatability and accuracy rating percentages are based on the full scale (except for salinity).
* 1: Organic solvents, strong acids, and strong alkaline solvents cannot be measured.
* 2: The maximum depth for ion measurements are 100 m for nitric acid ion, chloride ion, fluoride ion, 15 m for calcium ion, ammonia, and 3 m for potassium ion.
* 3: Based on the data measured automatically at 15 minutes intervals. The battery life taken into account. Periodical maintenance and calibration is necessary when a lot of shellfishes and seaweeds exist at the measurement point.

Influence of Hindering Ions, The values show permissible coexistence limits

Nitrate ion	ClO ₄ =0.03 I ⁻ =0.1 Br ⁻ =2 NO ₂ ⁻ =3 Cl ⁻ =40 F ⁻ =200 CH ₃ COO ⁻ =300 SO ₄ ²⁻ = more than 1000
Chloride ion	S ₂ O ₈ ²⁻ , S ²⁻ , I ⁻ , Ag ⁺ , Hg ²⁺ =Not possible SCN ⁻ =0.3 MnO ₄ ⁻ =0.1 Br ⁻ =0.03
Calcium ion	Fe ³⁺ =0.1 Fe ²⁺ , Zn ²⁺ =1 Sr ²⁺ =50 Ni ²⁺ , Cu ²⁺ =70 Co ²⁺ =350 Mn ²⁺ =500 Mg ²⁺ =1,000 Na ⁺ , K ⁺ , Ba ²⁺ , NH ₄ ⁺ =more than 1000
Fluoride ion	OH ⁻ =10, All negative ions except for OH ⁻ is permissible
Potassium ion	Rb ⁺ =0.4 Cs ⁺ =3 NH ₄ ⁺ =70 Li ⁺ , Na ⁺ , Mg ²⁺ , Ca ²⁺ , Sr ²⁺ , Ba ²⁺ =more than 1000
Ammonia	—

■ **External dimensions** unit: mm (in)

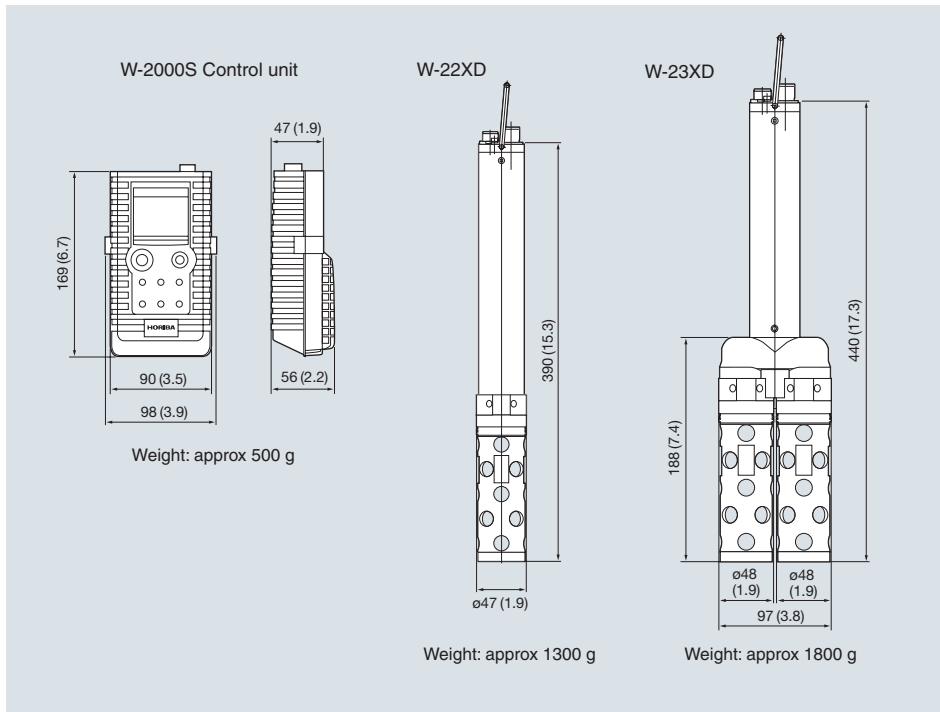

■ **Option**



Carrying Case

W-2030

*Multi-probe guard or Flow Through Cell can only be stored in W-2030



Multi-probe Guard

Model W-2200

*Multi-Probe not included



Flow Through Cell

Model W-2100

Applicable only for W-22XD.

User Registration

Upon online registration, you will have an advantage to download data collection software, technical reports, also sending technical inquires and more.

Visit <http://www.horiba-water.com> for online registration.

HORIBA continues contributing to the preservation of the global environment through analysis and measuring technology.



Please read the operation manual before using this product to assure safe and proper handling of the product.

- The contents of this catalog are subject to change without prior notice, and without any subsequent liability to this company.
- The color of the actual products may differ from the color pictured in this catalog due to printing limitations.
- It is strictly forbidden to copy the content of this catalog in part or in full.
- All brand names, product names and service names in this catalog are trademarks or registered trademarks of their respective companies.

<http://www.horiba.com> e-mail: info@horiba.co.jp

● **HORIBA, Ltd.**
Head Office
 Miyano Higashi, Kisshoin
 Minami-ku, Kyoto, Japan
 Phone: 81 (75) 313-8123
 Fax: 81 (75) 321-5725

● **Horiba India Private Limited**
Delhi Office
 1-7-8 Higashi-Kanda
 Chiyoda-ku, Tokyo, Japan
 Phone: 81 (3) 3861-8231
 Fax: 81 (3) 3861-8259

● **HORIBA TRADING (SHANGHAI) CO., Ltd.**
Shanghai Office
 Room 1701, United Plaza,
 1468 Nanjing Rd. West,
 Shanghai, 200040, China
 Phone: 21-6289-6060
 Fax: 21-6289-5553

● **HORIBA KOREA Ltd.**
 112-6 Sogong-Dong
 Choong-ku, Seoul, Korea
 Phone: 82 (2) 753-7911
 Fax: 82 (2) 756-4972

● **HORIBA INSTRUMENTS Pte. LTD.**
 10 Ubi Crescent
 #05-11/12, Ubi Techpark
 Singapore 408564
 Phone: 65 6745-8300
 Fax: 65 6745-8155

● **HORIBA India Private Limited**
Pune Office
 502, Purushottam Plaza,
 Baner Road, Baner,
 Pune - 411045 INDIA
 Phone: +91 20-2729-1121

● **HORIBA INSTRUMENTS INCORPORATED**
Irvine Facility
 17671 Armstrong Avenue
 Irvine, CA 92614, U.S.A.
 Phone: 1 (949) 250-4811
 Fax: 1 (949) 250-0924

● **HORIBA INSTRUMENTS LIMITED**
 Kyoto Close
 Summerhouse Road
 Moulton Park, Northampton
 NN3 6FL, U.K.
 Phone: 44 (1604) 542500
 Fax: 44 (1604) 542699

● **HORIBA GmbH**
 Kaplanstrasse 5
 A-3430 Tulln,
 Austria
 Phone: 43 (2272) 65225
 Fax: 43 (2272) 65230

● **HORIBA CZECHIA**
 Organizaci slozka Praha
 Petrohradská 13
 CZ-101 00 Praha 10,
 Czech Republic
 Phone: 420 (2) 717-464-80
 Fax: 420 (2) 717-470-64

● **HORIBA EUROPE GmbH**
Head Office
 Hans-Mess-Str.6
 D-61440 Oberursel/Ts.
 Germany
 Phone: 49 (6172) 1396-0
 Fax: 49 (6172) 137385

● **Leichlingen Facility**
 Julius-kronenberg Strasse
 D-42799 Leichlingen
 Germany
 Phone: 49 (2175) 8978-0
 Fax: 49 (2175) 8978-50

● **HORIBA FRANCE**
 12, Avenue des Tropiques
 91955 LES ULIS
 France
 Phone: 33 (1) 69-29-96-23
 Fax: 33 (1) 69-29-95-77

Bulletin:HRE-1932A

Printed in Japan ZK-K(SK)33