

Orion 210A+, 230A+,
250A+, 290A+

Orion Aplus Portable pH and ISE Meters

INSTRUCTION MANUAL

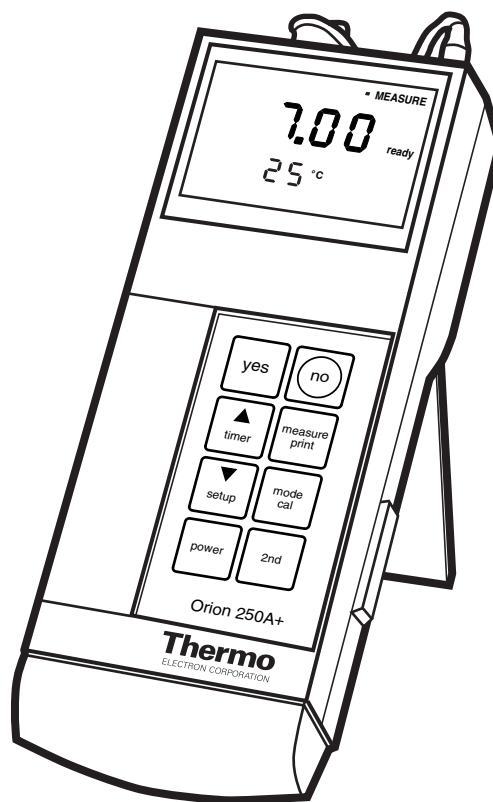

AQUAfast, Cahn, EZ Flash, Ionalyzer, ionplus, KNiPHE, No Cal, ORION, perpHect, PerpHecT, PerpHecTion, pHISA, pHix, pHuture, Pure Water, Sage, Sensing the Future, SensorLink, ROSS Ultra, Sure-Flow, TEA Analyzer, Titrator PLUS, TURBO2 and Wine Master are registered trademarks of Thermo Electron Corporation.

1-888-pHAX-ION, A+, All in One, Aplus, AQUAsnap, AssuredAccuracy, AUTO-BAR, AUTO-CAL, AUTO DISPENSER, Auto-ID, AUTO-LOG, AUTO-READ, AUTO-STIR, Auto-Test, BOD AutoEZ, Cable-Free, CERTI-CAL, CISA, DataCOLLECT, DataPLUS, digital LogR, DirectCal, DuraProbe, Environmental Product Authority, Extra Easy/Extra Value, FAST QC, Flash Titration, Flash Titrator, GAP, GLPcal, GLPcheck, GLPdoc, ISEasy, KAP, LabConnect, LogR, Low Maintenance Triode, Minimum Stir Requirement, MSR, NISS, One-Touch, One-Touch Calibration, One-Touch Measurement, Optimum Results, Pentrode, pHuture MMS, pHuture Pentrode, pHuture Quatrode, pHuture Triode, Quatrode, QuiKcheK, rlink, ROSS, ROSS Resolution, SAOB, Smart CheK, Stacked, Stat Face, The Enhanced Lab, ThermaSense, Triode, TRIUMPH, Unbreakable pH, Universal Access are trademarks of Thermo.

Guaranteed Success and The Technical Edge are service marks of Thermo.

PerpHecT meters are protected by U.S. patent 6,168,707.

PerpHecT ROSS are protected by U.S. patent 6,168,707.

ORION Series A meters and 900A printer are protected by U.S. patents 5,108,578, 5,198,093, and German patents D334,208 and D346,753.

Sure-Flow electrodes are protected by European Patent 278,979 and Canadian Patent 1,286,720.

ionplus electrodes and Optimum Results solutions are protected by US Patent 5,830,338.

ROSS Ultra electrodes have patents pending.

ORION ORP Standard is protected by US Patent 6,350,367.

ORION Series A conductivity meters are protected by US Patent 5,872,454.

© Copyright 2003, Thermo Electron Corporation. All rights reserved. Question everything, and Analyze. Detect. Measure. Control are trademarks of Thermo Electron Corporation.

The specifications, descriptions, drawings, ordering information and part numbers within this document are subject to change without notice.

This publication supersedes all previous publications on this subject.

Table Of Contents

Chapter I	Introduction	1
Chapter II	General Information	3
	A. Top Panel	4
	B. Rear Panel	5
	C. Electrode Clip	6
	D. Electrode Storage Compartment	7
	E. RS232 Interface	8
Chapter III	Set Up, Self-Test Procedure	9
	A. Power Source	9
	B. Battery Installation	9
	C. Power Up and Self-Test	10
	D. Electrode Connections	11
Chapter IV	Orion 210Aplus	13
	A. Display	13
	B. Keypad	14
	C. Self-Test and Checkout Procedure	15
	D. SETUP Menu	16
	Resolution	16
	Slope	16
	Calibration Buffer Option	16
	E. Calibration and Measurement Procedures	17
	pH Measurements	17
	Autocalibration	17
	Manual Calibration	20
	F. Dissolved Oxygen Measurements	23
Chapter V	Orion 230Aplus	25
	A. Display	25
	B. Keypad	27
	C. Self-Test and Checkout Procedure	29
	D. SETUP Menu	30
	E. Calibration and Measurement Procedures	32
	pH Measurements	32
	Autocalibration	32
	Manual Calibration	35
	ORP Relative to Normal Hydrogen Electrode (NHE)	38
	Setting ORP Millivolts Offset	38
	F. Dissolved Oxygen Measurements	39
Chapter VI	Orion 250Aplus	41
	A. Display	41

B. Keypad	43
C. Self-Test and Checkout Procedure	45
D. SETUP Menu	46
E. Calibration and Measurement Procedures	49
pH Measurements	49
Autocalibration	49
Manual Calibration	52
Millivolt Measurements	54
ORP Relative to Normal Hydrogen Electrode (NHE)	55
Setting ORP Millivolts Offset	55
F. Dissolved Oxygen Measurements	56
Chapter VII Orion 290Aplus	57
A. Display	57
B. Keypad	59
C. Self-Test and Checkout Procedure	61
D. SETUP Menu	63
E. Calibration and Measurement Procedures	68
pH Measurements	68
Autocalibration	68
Manual Calibration	69
Concentration Measurements	72
Millivolt Measurements	76
F. Dissolved Oxygen Measurements	77
Chapter VIII Temperature Compensation	79
Chapter IX Use with Accessories	81
A. Use with Printers and Computers	81
B. Remote Control	82
Chapter X Troubleshooting	85
A. Self-Test	85
B. Operator Assistance Codes	87
C. Troubleshooting Guide	92
Chapter XI Instrument Warranty	93
Chapter XII Service and Repair	97
Chapter XIII Notice of Compliance	99
Chapter XIV Ordering Information	101
Chapter XV Specification	103

Chapter I

Introduction

Orion's Portable Meters are compact, battery operated and microprocessor controlled for all measurement needs. All meters feature a custom digital LCD display, which simultaneously displays temperature along with measurement results. Ideal for field, plant, or laboratory use, each meter is lightweight and designed to fit comfortably in the hand.

A flip stand allows easy use in the lab.

The Orion 210Aplus is a basic pH meter that features 2 point autocalibration.

The Orion 230Aplus is a pH meter that features autocalibration and automatic temperature compensation, millivolt, relative millivolt and (E_H) ORP mode.

The Orion 250Aplus has all the features of the 230Aplus plus 3 point auto calibration and RS232-C output for use with the Orion 900A printer or other serial peripherals.

The Orion 290Aplus adds concentration measurements and an internal datalogging function to make a truly versatile meter for pH or ISE analysis.

This manual contains instructions for all four meters. See the calibration and measurement section for details on your particular meter. The general information section contains descriptions of hardware which pertain to all meters. The Temperature Compensation and Troubleshooting sections contain information applicable to all meters.

Chapter II

General Information

Orion's Portable Meters have a large custom LCD display and keypad with tactile and audible feedback. Designed for one-handed operation each features an electrode clip to attach electrode directly to meter and molded grip area. (Electrode clips included in Portable Meter Starter Kit, Orion No. OPBLSK)

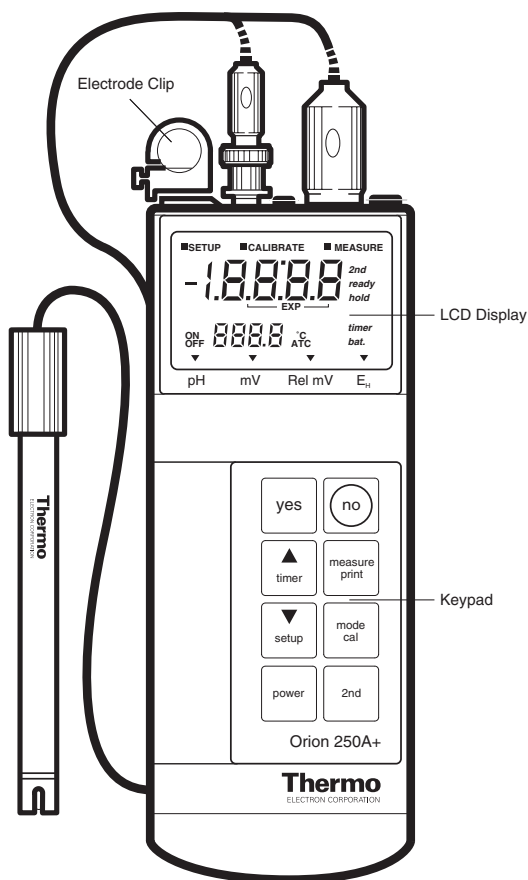

Figure 1: Front Panel Orion 250Aplus

A. Top Panel

1. Electrode Connections: Accepts BNC connector from combination or half-cell sensing electrode(s) (1A). A separate pin tip (1B) accepts a reference electrode.
2. ATC Probe Jack: Accepts thermistor type Automatic Temperature Compensation probe with DIN connector.
3. Line Converter Jack: Accepts an AC line converter for use without batteries.

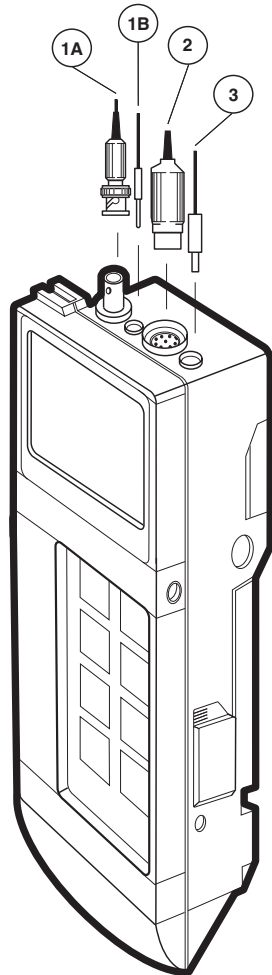

Figure 2: Top Panel Orion 250Aplus

B. Rear Panel

1. Battery Compartment: Accepts one 9 V battery, either alkaline or lithium.
2. Setup Menu Label: Identifies setup parameters and corresponding I.D. codes.
3. Electrode Clip: Attaches an electrode directly to the meter for one-handed operation.
4. Electrode Storage Compartment: Stores electrode in between measurements. Compartment can contain electrode storage solution to keep electrode moist and ready for use.
5. Cable Management: The cable(s) from the electrode(s) will slide under the left side of the storage compartment.

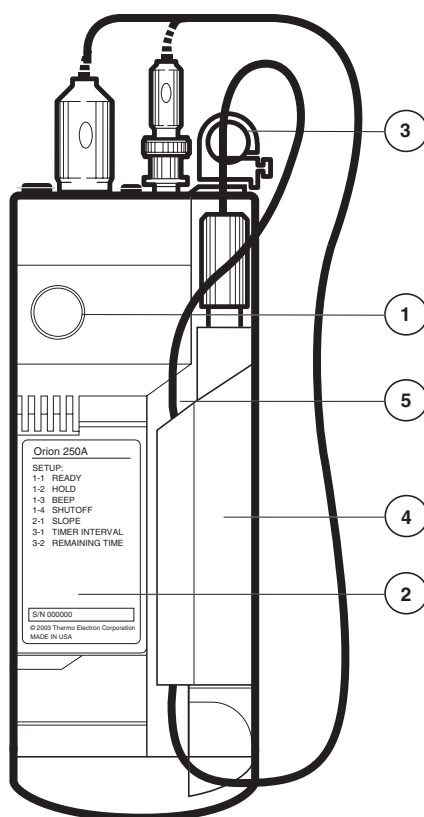

Figure 3: Rear Panel Orion 250Aplus

C. Electrode Clip

The electrode clip allows easy one-handed dip and read operation. Two or more electrodes may be joined together and then attached directly to the meter.

1. Slide electrode clip onto electrode.
2. If using two electrodes, slide second electrode clip into opening on the first electrode clip (see illustration).
3. Attach electrode(s) to meter by sliding clip from left to right into meter until securely seated.

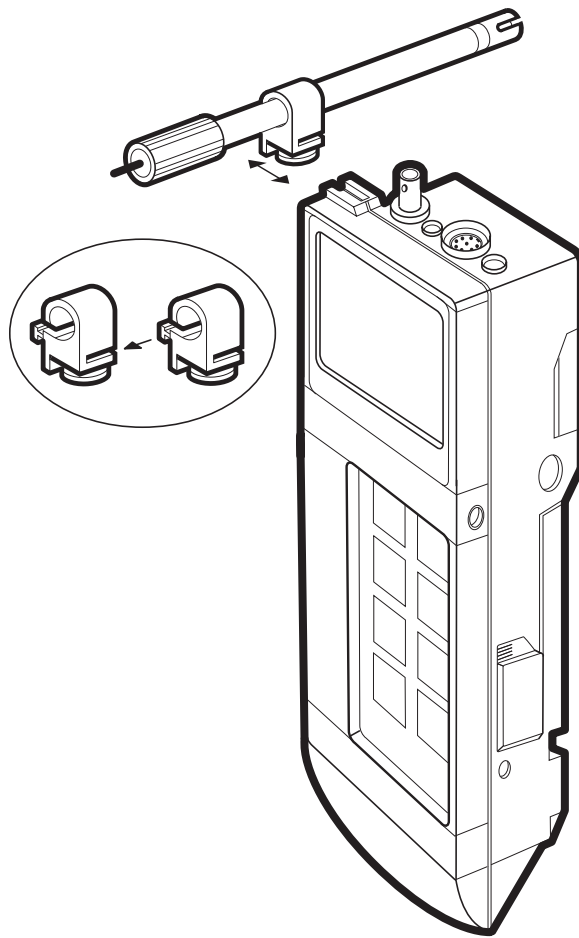

Figure 4: Electrode Clip

D. Electrode Storage Compartment

The electrode storage compartment provides a convenient place for electrode storage between measurements and in the field. Add a few drops of pH electrode storage solution Orion No. 910001 to the storage compartment cap to ensure your electrode will be ready for use. The entire compartment is removable for easy cleaning.

The right-hand side of the compartment (when the meter is turned over and facing down) provides a space for the electrode cables. Slide the cable underneath the edge of the compartment.

1. With the meter facing down slide the compartment to the right to remove.
2. Rinse with distilled or deionized water.
3. Replace compartment by lining up pins on meter with slides on electrode storage compartment then slide to the left until firmly in place.

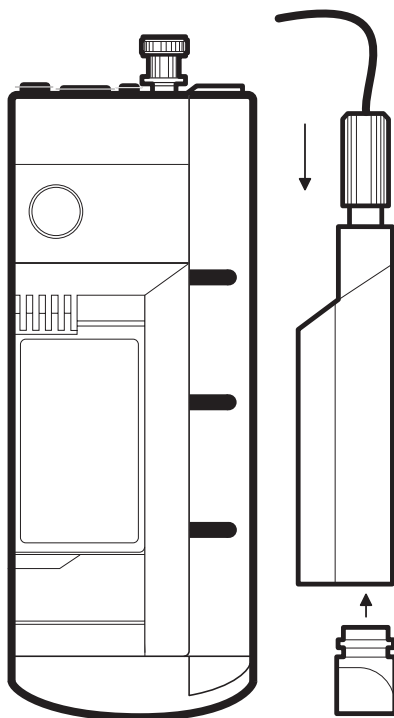

Figure 5: Electrode Storage Compartment

E. RS232-C Interface

Both the Orion 250Aplus and 290Aplus have an RS232-C interface for use printers or serial peripherals.

The Orion 250Aplus has a one way interface for communication with the Orion 900A printer or other device. The instrument can send (but not receive) information via this port.

The Orion 290Aplus has a bi-directional interface for communication with printers or computers. The instrument can send or receive information using this port.

The Orion 900A printer is battery operated and attaches directly to either meter making a compact package for field measurement and recording. See printer manual, part no. 213377-001.

Chapter III

Set Up and Self-Test Procedures

A. Power Source

The Orion Portable Meters operate on either one 9V alkaline battery, one 9V lithium battery, or an AC line adapter. The estimated battery life is 50 hours of continuous operation for an alkaline battery and 100 hours of continuous operation for a lithium battery. Insert battery as described below or plug in the line adapter.

B. Battery Installation

1. Open battery compartment by pushing closure up. This is most easily accomplished by using a coin (such as a dime) and inserting it into the slot on the side of the meter.
2. Insert battery pushing gently until it locks in place. Ensure polarity is correct as shown in the battery compartment.
3. Replace battery compartment cover.

NOTE: After replacing the battery, recalibrate meter. Without the battery installed or meter plugged into line power, the meter loses calibration data and other information in memory. To prevent loss of data in the field, turn meter off if the low battery signal comes on. Check and replace batteries regularly prior to field use.

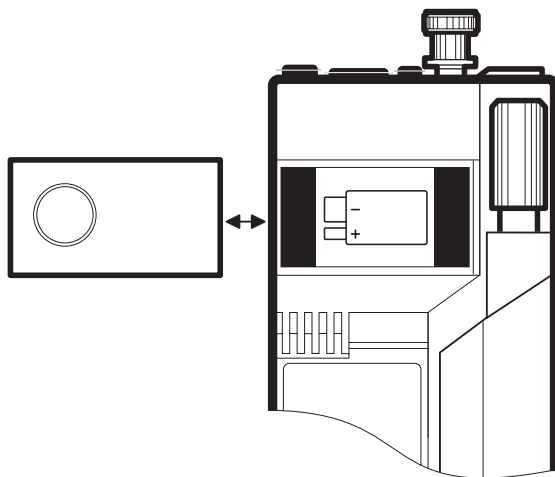

Figure 6: Battery Compartment

C. Power Up and Self-Test

NOTE: Use this procedure when the instrument is first received and whenever troubleshooting becomes necessary.

1. Attach the BNC Shorting Plug (Orion No. 090045) to BNC connector on top of meter.
2. Press the **power** key to turn meter on.
3. If battery indicator remains on, replace battery or use line adapter.
4. Press the **power** key to turn meter off.
5. Press the **power** key and quickly press the **yes** key to start the self-test. (Alternatively, press and hold the **yes** key while pressing the **power** key). The instrument automatically performs electronic and hardware diagnostic tests. For a more detailed explanation, see the self-test section of the troubleshooting guide.
6. When the code 7 appears in the lower display field, "0" will be displayed, press each key, including the **power** key, one at a time. A numeric digit will be displayed upon each key press.

NOTE: All keys must be pressed within 10 seconds to complete test 7.

7. For Orion 210Aplus or Orion 230Aplus: After the keypad test, the meter will shut off.

For Orion 250Aplus or Orion 290Aplus: After the keypad test, the meter will turn off then back on again. After completing the self-test, the meter will resume normal operation.

8. If any problems are found during self-test, the meter will display the operator assistance code until acknowledged by pressing the **yes** key. See **Troubleshooting** section.

D. Electrode Connections

Orion Triode

Attach Orion TRIODE electrode by sliding the BNC connector onto the sensor input then push down and turn clockwise to lock into position. Slide the DIN connector into the ATC jack until it is firmly seated.

Other Electrodes

Attach electrodes with BNC connectors to sensor input by sliding connector onto input, pushing down and turning clockwise to lock into position. Connect reference electrodes with pin tip connectors by pushing connector straight into reference input.

NOTE: If using a combination electrode with a BNC connector, the reference pin-tip is not used.

ATC Probe

Attach the ATC probe to the ATC jack by sliding the connector straight on until firmly in place. The connector has a special sealing mechanism, which is engaged when the connector is properly attached, to prevent moisture from penetrating the meter.

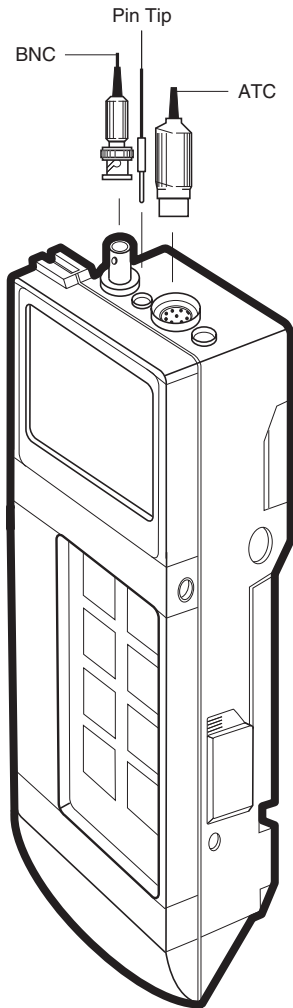

Figure 7: Electrode Connections

Chapter IV

Orion 210Aplus

A. Display

Operating Mode	Indicates instrument operating mode.
<i>SETUP</i>	<i>Indicates meter is in setup mode. Used to define operating parameters.</i>
<i>CALIBRATE</i>	<i>Indicates meter is in calibration mode.</i>
<i>MEASURE</i>	<i>Indicates meter is in measurement mode.</i>
Main Field	Displays pH readings, electrode slope and other significant information.
Lower Field	Displays temperature in degrees Celsius. The °C designation is displayed when temperature is displayed.
ATC	Displayed when a temperature probe is attached.
READY	Displayed when the electrode signal has stabilized. The Ready function may be turned on or off in the setup menu.
BAT	Displayed when the battery is low and needs to be replaced.

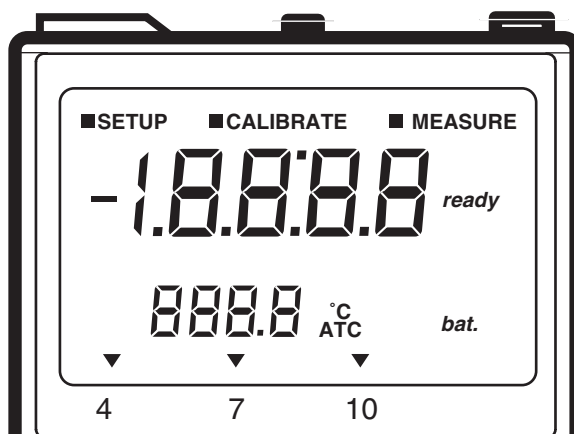

Figure 8: 210Aplus Display

B. Keypad

- yes** Press to enter a value during calibration or setup. May also be used to scroll through the setup menu without changing any parameters.
- no** Press to cancel a change to a parameter before entering. May also be used to initiate a change in current setup parameter.
- mode** Press to select operating mode: SETUP, CALIBRATE or MEASURE.
- power** Press to turn meter on or off.

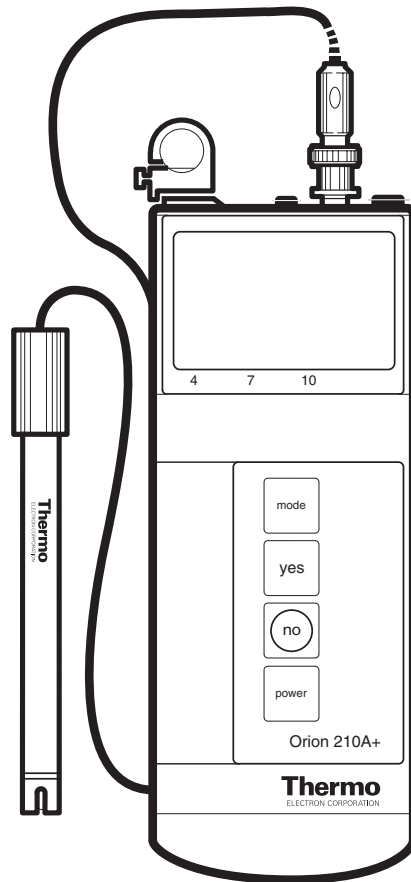

Figure 9: 210Aplus Keypad

C. Self Test and Checkout Procedure

This procedure should be performed when the meter is received and when operation problems arise. This procedure verifies the proper operation of the Orion 210Aplus Meter.

1. Attach the Orion shorting cap to the meter.
2. Press the **power** key to turn meter on.
3. If the low battery indicator remains on, replace the battery or use a line adapter.
4. Press the **power** key to turn meter off.
5. Press the **power** key and quickly press the **yes** key to start the self-test. The meter automatically performs electronic and hardware diagnostic tests.
6. When the code 7 appears in the lower display field, "0" will be displayed, press each key, including the **power** key, one at a time. A numeric digit will be displayed upon each key press.
7. After the self-test is complete, the meter will automatically shut off. To restart the meter, press the **power** key.
8. If any problems are found during the self-test, the meter will beep and an operator assistance code will be displayed until acknowledged by pressing the **yes** key. See **Troubleshooting**.

D. SETUP Menu

Select SETUP mode by pressing the **mode** key until SETUP is displayed. The SETUP mode is used to define, change or view meter operating parameters. While in the SETUP mode, the **yes** key is used to scroll through the menu without changing parameters and to enter new parameters into meter memory. The **no** key is used to scroll through options within each parameter. To exit the SETUP mode, press the **mode** key at any time.

The following parameters are accessed in the SETUP mode:

Resolution

The current pH resolution will be displayed. The default setting is two decimal places (i.e. pH 7.00). Press the **yes** key to agree with setting or press the **no** key to change to 7.0 and then press the **yes** key to accept the new setting.

Slope

The current electrode slope in meter memory will be displayed. The value is displayed as a percent of theoretical slope. The default setting is 100%. This function is for display purposes only. The value can not be changed in the SETUP menu. To change the slope value, perform a two buffer calibration or set slope during a one buffer calibration. Press the **yes** key to advance to next menu option.

Cal. Buffer Option

The current calibration buffer option in meter memory will be displayed as STD “570” or SET “5E7” on the temperature display.

Auto Calibration Buffer Option

When the “570” option is selected, calibration may only be performed with standard buffers: pH 4.01, 7.00 and 10.01.

Manual Calibration Buffer Option

When the “5E7” option is selected, calibration may be performed with user defined buffers within the range of 0 to 14 pH.

***NOTE:** The chosen buffers must be greater than one (1) pH unit but less than four (4) pH units from each other.*

E. Calibration and Measurement Procedures

pH Measurements

A one or two buffer calibration should be performed before pH is measured. It is recommended that a two buffer calibration, using buffers that bracket the expected sample range, be performed at the beginning of each day to determine the slope of the electrode. This serves the dual purpose of determining if the electrode is working properly and storing the slope value in memory. Perform a one buffer calibration every two hours to compensate for electrode drift.

Prior to calibration, scroll through the setup menu and ensure all parameters are set correctly for the analysis you want to perform.

There are two ways of calibrating the 210Aplus Meter: autocalibration or manual calibration. Following are descriptions and instructions for each method.

Autocalibration

Autocalibration is a feature of the Orion 210Aplus Meter that automatically recognizes the buffers 7.00, 4.01 and 10.01 within a range of (0.5 pH units). Simply select the buffer sequence that best fits your application, choose between, 7 - 10; 7 - 4; or a one point autocalibration with pH 7. During calibration wait for READY to be displayed, indicating electrode stability. Once the electrode is stable, the meter automatically recognizes and displays the temperature-corrected value for that buffer. Press the **yes** key to enter the value into memory.

The 210Aplus Meter compares actual values to theoretical values to determine if the buffer is within range. Results greater than (0.5 pH units) from the theoretical value will trigger an operator assistance code. For best results, it is recommended that an ATC probe be used. If an ATC probe is not used all samples and buffers should be at the same temperature or manual temperature compensation should be used.

Autocalibration with Two Buffers

1. Connect the electrode(s) to meter. Choose either 4.01 and 7.00, or 7.00 and 10.01 buffers, whichever will bracket your expected sample range.
2. Rinse the electrode(s) and place into the 7.00 buffer.
3. Press the **mode** key until CALIBRATE is displayed above the main readout. The last buffer sequence used will be displayed. Press the **yes** key to use this sequence, or press the **no** key to scroll through other choices, and then press the **yes** key when the desired sequence is displayed.
4. The buffer indicator along the bottom of the display will indicate the buffer chosen. P1 will be displayed in lower display field and buffer reading will be displayed in the main field.
5. When READY is displayed, indicating electrode stability, the temperature-corrected value for the buffer is displayed. Press the **yes** key. The display will remain frozen for two seconds. Then P2 is displayed in the lower field indicating the meter is ready for the second buffer. The buffer indicator along the bottom of the display will indicate the second buffer of the calibration sequence selected.
6. Rinse the electrode(s) and place into the second buffer.
7. When READY is displayed, indicating electrode stability, the temperature-corrected value for the buffer is displayed. Press the **yes** key. The display will remain frozen for two seconds.
8. After the second buffer value has been entered, the electrode slope will be displayed. SLP appears in the lower field while the actual electrode slope (in percent) appears in the main field for 5 seconds.
9. The meter will then automatically advance to the measure mode and MEASURE is displayed above the main display field.
10. Rinse the electrode(s) and place into the sample. Record pH and temperature directly from the meter display.

Autocalibration with One Buffer

NOTE: Autocalibration with one buffer can only be performed using buffer 7.00

1. Attach the electrode(s) to the meter.
2. Rinse the electrode(s) and place into 7.00 buffer.
3. Press the **mode** key until CALIBRATE is displayed above the main readout. The last buffer sequence used will be displayed. Press the **no** key until 7 is displayed. Then press the **yes** key.
4. The buffer indicator along the bottom of display will indicate the buffer selected (7) and P1 will be displayed in the lower field. The buffer reading will be displayed in the main field.
5. When READY is displayed, indicating electrode stability, press the **yes** key. The temperature-corrected value for that buffer is entered into the memory of the meter.
6. SLP will appear in the lower display field and the current electrode slope in memory is displayed in the main field. Press the **yes** key to accept value or press the **no** key to change value. The value in the main display will blink. Begin editing with the left most digit. Pressing the **no** key will scroll the value. Set digit to desired value and press the **yes** key. Continue editing each digit until desired slope value is entered into memory.
7. The meter will then automatically advance to the measure mode and MEASURE is displayed above the main display field. Rinse the electrode(s) and place into sample. Both the temperature-corrected pH reading and temperature reading are displayed. Record reading when READY is displayed.

Manual Calibration

Manual Calibration with Non-Standard Buffers

The Orion 210Aplus Meter features a manual calibration option when the use of non-standard buffers is required for calibration. Simply enter the values of the buffers to be used into the memory of meter in the SETUP menu. For best results, buffer values entered must be the value of the buffers at the temperature at which calibration is being performed. Once these values have been entered, SET (5E7) will appear in the buffer sequence selections. Select SET and the meter will automatically recognize the buffer values which were entered in the SETUP menu. These values will remain in the meter memory until new values are entered.

***NOTE:** The calibration buffers should be used during the calibration in the same sequence as they are entered in the SETUP mode.*

Setting the Manual Buffer Option

Two non-standard buffer values may be set for use in performing calibrations. The manual buffer pH range is 0 - 14. After these values have been entered into the memory of the meter, the meter will automatically use these values during calibration whenever the SET option is selected during buffer sequence selection at the start of calibration.

NOTE: The difference between the two non-standard buffers must be at least 1 pH unit and no more than 4 pH units.

1. Select the SETUP mode, by pressing the **mode** key repeatedly until SETUP is displayed. Press the **yes** key twice.
2. STD (570) will be displayed. Press the **no** key. SET (5E7) will be displayed. Press the **yes** key.
3. The value in the main display will blink and P1 will be displayed in the lower display indicating that the first buffer value is being set.
4. Begin editing with the digit furthest to the left. Press the **no** key to scroll the value between 0 and 1. Set digit to desired value and press the **yes** key.
5. Continue editing the value for each digit until the desired buffer value has been entered then press the **yes** key to enter the buffer value into the meter memory.
6. The value in the main display will blink and P2 will be displayed in the lower display indicating that the second buffer value is being set.
7. Begin editing the value for each digit until the desired buffer value has been entered and press the **yes** key to enter the buffer value into the meter memory.
8. The meter will automatically return to the beginning of the SETUP menu. Press the **mode** key to exit the SETUP menu.

Manual Calibration with Two Buffers

1. Attach the electrode(s) to the meter. Choose two buffers that will bracket your expected sample range.
2. Rinse the electrode(s) and place into the first buffer.
3. Enter the non-standard buffer values into meter memory as described in Setting Manual Buffer Option, page 21 .
4. Select calibration mode by pressing the **mode** key repeatedly until CALIBRATE is displayed.
5. The last buffer sequence used will be displayed for 2 seconds. If SET is displayed press the **yes** key, otherwise press the **no** key repeatedly until SET is displayed. Then press the **yes** key.
6. The buffer indicator along the bottom of the display will show MAN indicating manual buffer option selected. P1 will be displayed in the lower display field and the buffer reading will be displayed in the main field.
7. When READY is displayed, indicating electrode stability, press the **yes** key. P2 will be displayed in the lower display field indicating the meter is ready for the second buffer.
8. Rinse the electrode(s) and place into the second buffer.
9. When READY is displayed, press the **yes** key.
10. After the second buffer value has been accepted, the electrode slope will be displayed. SLP appears in the lower field while the actual electrode slope (in percent) is displayed in the main field for 5 seconds.

The meter will then automatically advance to the measure mode and MEASURE is displayed above the main display field. The buffer indicator, indicates MAN, manual buffer calibration option was used in the last calibration.

11. Rinse the electrode(s) and place into the sample. If using an ATC probe, then both the temperature-corrected pH reading and temperature reading are displayed. Record the reading when READY is displayed.

For best results, it is recommended that an ATC probe be used. If an ATC probe is not used, all samples and standards should be at the same temperature or manual temperature compensation should be used.

F. Dissolved Oxygen Measurements

Dissolved oxygen measurements are displayed in ppm when the Orion 97-08 Dissolved Oxygen Electrode is used with the Orion 210Aplus Meter. Follow these instructions for preparing the meter and calibrating the electrode.

1. Connect the Orion 97-08 to meter and leave electrode mode switch “OFF”.
2. Disconnect the ATC probe.
NOTE: ATC probe must not be connected to the meter
3. While in MEASURE mode, use the **no** key to change the temperature value to 25.0 °C.
4. Press the **mode** key repeatedly until CALIBRATE is displayed. The last buffer sequence used will be displayed. Press the **no** key until 7 is displayed, then press the **yes** key.
5. When READY is displayed, indicating electrode stability, press the **yes** key.
6. SLP will appear in the lower display field and the current electrode slope in memory is displayed in the main field. Press the **no** key to change value to 100.0, then press the **yes** key.
7. The meter will then automatically advance to the measure mode and MEASURE is displayed above the main display field.
8. Turn the mode switch on the electrode to BT CK. Good battery operation is indicated by a reading of 13.40 or greater on the meter.
9. Turn the mode switch on the electrode to ZERO. Use the zero calibration control to set the meter to read 0.00.

10. Insert the reservoir (funnel) into a BOD bottle containing enough water to just cover the bottom. Insert the electrode, making sure that the electrode tip is not immersed in the water and does not have water droplets clinging to the outside of the membrane. Let stand approximately 30 minutes to ensure water saturation of air in the BOD bottle. This bottle should be used for storage between measurements.
11. Turn the electrode mode switch to the AIR position. If measurements are being made at sea level use the AIR calibration control on the electrode to set the pH meter reading to the prevailing barometric pressure in mm Hg (divided by 100). If the barometric pressure is unknown, if the elevation is above sea level or if the sample has a salinity greater than 2 parts per thousand, consult Table 1 found in the Orion 97-08 Instruction Manual to obtain the correct AIR setting.
12. Turn the electrode mode switch to H₂O for sample analysis.

Chapter V

Orion 230Aplus

A. Display

Operating Mode	Indicates instrument operating mode.
<i>SETUP</i>	<i>Indicates meter is in setup mode. Used to define operating parameters.</i>
<i>CALIBRATE</i>	<i>Indicates meter is in calibration mode. Accessed by pressing the 2nd then cal keys.</i>
<i>MEASURE</i>	<i>Indicates meter is in measurement mode. Accessed by pressing the measure key.</i>
Main Field	Displays pH readings, electrode slope and other significant information depending on the meter operating mode.
ON/OFF	Indicates if a particular feature is active or not in the SETUP menu.
Lower Field	Displays temperature in degrees Celsius. The °C designation is displayed when temperature is displayed.
ATC	Displayed when a temperature probe is attached.

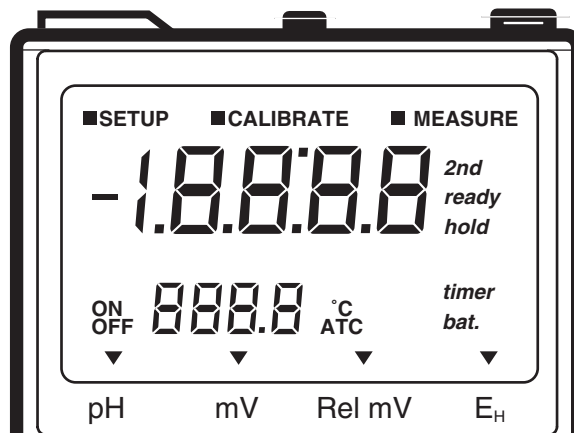

Figure 10: 230Aplus Display

2nd	Displayed when the 2nd key has been pressed, indicating the meter is ready to perform a secondary function.
READY	Displayed when the electrode signal has stabilized. The READY function may be turned on or off in the setup menu.
HOLD	Displayed when the pH reading is frozen after reaching stability in measure mode. The HOLD feature may be turned on or off in the SETUP menu.
TIMER	Displayed when the timer function has been activated.
BAT	Displayed when the battery is low and needs to be replaced.
Mode Indicator	Designates instrument measurement mode either pH, millivolts (mV) or Relative millivolts (Rel mV) or ORP Relative to Normal Hydrogen Electrode (NHE).

B. Keypad

Primary Functions

yes	Press to enter a value during calibration or setup. May also be used to scroll through the setup menu without changing any parameters.
no	Press to cancel a change to a parameter before entering.
measure	Press for sample analysis. Instrument will remain in measure mode until another key is pressed. Press to unlock hold.
2nd	Press to access second functions: timer, cal or setup menu.
▲	Press to increase value.
▼	Press to decrease value.
power	Press to turn meter on or off.
mode	Press to change measurement modes. The options are pH, mV, Rel mV, or E _H .

Second Functions

All second functions are accessed by first pressing the **2nd** key.

- timer** Press to start the timer. When the preset time has elapsed the instrument will beep for 1 minute (or until a key is pressed).
- setup** Press to access the setup menu. This is used for setting instrument operating parameters.
- cal** Press to start calibration. Meter automatically advances to measure after the calibration is complete.

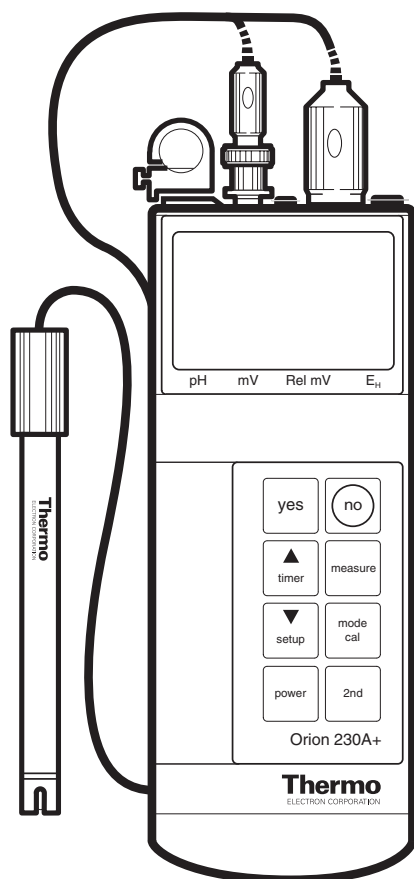

Figure 11: 230Aplus Keypad

C. Self Test and Checkout Procedure

1. Attach the BNC Shorting Plug (Orion No. 090045) to BNC connector on top of meter.
2. Press the **power** key to turn meter on.
3. If battery indicator remains on, replace battery or use line adapter.
4. Press the **power** key to turn meter off.
5. Press the **power** key and quickly press the **yes** key to start the self-test. (Alternatively, press and hold the **yes** key while pressing the **power** key). The instrument automatically performs electronic and hardware diagnostic tests. For a more detailed explanation, see the self-test section of the Troubleshooting guide.
6. When the code 7 appears in the lower display field, "0" will be displayed, press each key, including the **power** key, one at a time. A numeric digit will be displayed upon each key press.

NOTE: All keys must be pressed within 10 seconds to complete test 7.

7. After the keypad test, the meter will shut off. After completing the self-test, the meter will resume normal operation.
8. If any problems are found during self-test, the meter will display the operator assistance code (for details, see page 83) until acknowledged by pressing the **yes** key.
9. Press the **power** key to turn meter on. Press the **measure** key. Main display should read a steady 7.00 ± 0.02 . If not, follow steps 9a through 9b.
 - a. Press the **cal** key, when the display flashes 7.00, press the **yes** key.
 - b. Press the **measure** key. The main display should read 100.0, with the legend SLP, in the lower display. If so, press the **yes** key. If not, scroll until the display reads 100.0, then press the **yes** key. The meter advances to measure and the display should now read a steady 7.00.
10. The meter is now ready for use with a pH electrode. Remove the shorting plug.

D. SETUP Menu

The SETUP menu is used to identify and change instrument operating parameters. While in SETUP, the **yes** key is used to scroll through the menu without changing any parameters. To change a parameter, press one of the scroll keys, **▲** or **▼**, then the **yes** key to enter the change into the meter memory. Pressing the **no** key restores the parameter to its former state (if done before entering the new setting).

To enter the SETUP menu, press the **2nd** then the **setup** keys. 1-1 and READY will be displayed. The ON or OFF indicator will flash indicating the current status. Press the **yes** key to accept and continue through the menu. Press a scroll key, **▲** or **▼**, to change. After changing a setting, press the **yes** key to enter into the meter memory.

To change a numeric value, press the **▲** or **▼** key. The first digit will start flashing, scroll until the first digit is the desired value, then press the **yes** key to accept. The second digit will flash. Scroll until the desired value is displayed, then press the **yes** key to accept. Continue in this manner until all digits have been changed to the desired value, then press the **yes** key to enter into the meter memory.

Scroll through the SETUP menu accepting or changing parameters as desired. To exit the SETUP menu, press the **cal** key to begin the CALIBRATION sequence or press the **measure** key to analyze samples.

The following parameters are accessed in the SETUP menu.

- | | |
|-----------|--|
| 1-1 READY | Turning READY on will cause the ready indicator to be displayed when the electrode signal is stable. It is always on during calibration and when hold is turned on. The default setting is on. |
| 1-2 HOLD | Turning HOLD on will cause the display to freeze during sample measurements when the electrode signal is stable. Press the measure key to unlock HOLD during analysis. The default setting is off. |
| 1-3 BEEP | Turning BEEP on will cause an audible signal to sound when a key is pressed, when the electrode signal is stable (on ready), and when an operator assistance code is displayed. The default setting is on. |

- 1-4 AUTO-SHUTOFF Turning AUTOSHUTOFF on will cause the meter to turn off if no keys have been pressed for 10 minutes. This feature will save battery life. The default setting is on.
- 2-1 SLOPE Allows review of electrode slope in memory at any time. Value cannot be changed in the SETUP menu.
- 3-1 TIMER INTERVAL Used to set the timer interval. The maximum interval that can be set is 23 hours, 59 minutes and 59 seconds. The minimum interval is five (5) seconds. When the TIMER INTERVAL code, (3-1), is displayed, the current interval hours setting is first displayed in the main field (H 00). Press the **yes** key to accept the current setting or scroll to the desired value, then press the **yes** key to accept. Next, the current interval minutes:seconds will be displayed. Press the **yes** key to accept or scroll to the desired value then press the **yes** key. The default setting is five seconds.
- 3-2 TIME REMAINING Allows review of the time remaining before the TIMER is set to go off. If the timer has not been activated, 00:00 will be displayed.

E. Calibration and Measurement Procedures

pH Measurements

A one or two buffer calibration should be performed before pH is measured. It is recommended that a two buffer calibration, using buffers that bracket the expected sample range, be performed at the beginning of each day to determine the slope of the electrode. This serves the dual purpose of determining if the electrode is working properly and storing the slope value in the memory. Perform a one buffer calibration every two hours to compensate for electrode drift.

Prior to calibration, scroll through the SETUP menu and ensure all parameters are set properly for the analysis you want to perform. Select the desired resolution and verify that the isopotential point is set correctly for the electrode.

There are two ways of calibrating the 230Aplus Meter: autocalibration or manual calibration. Following are descriptions and instructions for each method.

Autocalibration

Autocalibration is a feature of the Orion 230Aplus Meter that automatically recognizes the buffers 7.00, 4.01 and 10.01 with a range of ± 0.5 pH units. During calibration, the user waits for a stable pH reading. Once the electrode is stable, the meter automatically recognizes and displays the temperature-corrected value for that buffer. Press the **yes** key to enter the value into the meter memory.

***NOTE:** Do not scroll when using autocalibration.*

The 230Aplus Meter compares actual values to theoretical values to determine if the buffer is within range. Results greater than ± 0.5 pH units from the correct value will trigger an operator assistance code. For best results, it is recommended that an ATC probe be used. If an ATC probe is not used all samples and buffers should be at the same temperature or manual temperature compensation should be used.

Autocalibration with Two Buffers

1. Connect the electrode(s) to meter.
Choose either 4.01 and 7.00 or 7.00 and 10.01 buffers, whichever bracket your expected sample range.
2. Press the **mode** key until the pH mode indicator is displayed.
3. Rinse the electrode(s) and place into the first buffer.
4. Press the **2nd** then the **cal** keys. CALIBRATION is displayed above the main field and the time and date of the last calibration are displayed. After a few seconds, P1 is displayed in lower field. P1 indicates that the meter is ready for the first buffer and a value has not yet been entered.
5. When READY is displayed, indicating electrode stability, the reading begins to flash, press the **yes** key. The display will remain frozen for two seconds. Then P2 will be displayed in the lower field indicating that the meter is ready for the second buffer.
6. Rinse the electrode(s) and place into the second buffer. After the second buffer value has been entered, the electrode slope will be displayed. SLP appears in the lower field with the actual electrode slope, in percent, in the field.
The meter automatically advances to the measure mode. MEASURE is displayed above the main field.
7. Rinse the electrode(s) and place into sample. Record pH directly from the meter display and temperature from the lower field.

Autocalibration with One Buffer

1. Connect the electrode(s) to meter. Select one buffer, either 4.01, 7.00 or 10.01, whichever most closely approximates the expected sample pH.
2. Press the **mode** key until the pH mode indicator is displayed.
3. Rinse the electrode(s) and place into the buffer and press the **2nd** then the **cal** keys. CALIBRATE will be displayed above the main field and the time and date of the last calibration will be displayed. After a few seconds, P1 will be displayed in the lower field.
4. When READY is displayed, indicating electrode stability, and the reading begins to flash, press the **yes** key. The display remains frozen for two seconds. Then P2 is displayed in the lower field.
5. Press the **measure** key. SLP will be displayed in the lower field and the electrode slope in memory in the main field. If necessary, enter the correct electrode slope determined by a two point calibration and press the **yes** key. If slope value is unknown, enter 100.0 or perform a two buffer calibration.
6. Rinse the electrode(s) and place into sample. Read the pH directly from the main display and temperature from the lower field.

Manual Calibration

To calibrate with buffers other than 4.01, 7.00 or 10.01, use the manual calibration technique. The calibration sequence is the same as autocalibration except buffer values are manually entered using the scroll keys.

For best results, it is recommended that an ATC probe be used. If an ATC probe is not used, all samples and standards should be at the same temperature or manual temperature compensation should be used. See page 79.

Manual Calibration with Two Buffers

1. Connect the electrode(s) to meter. Choose two buffers that will bracket your expected sample range.
2. Press the **mode** key until the pH mode indicator is displayed.
3. Rinse the electrode(s) and place into the first buffer.
4. Press the **2nd** then the **cal** keys. CALIBRATE will be displayed above the main readout and the time of the last calibration will be displayed. After a few seconds, P1 will be displayed in the lower field.
5. When READY is displayed, indicating electrode stability, and the reading begins to flash, press the ▲ or ▼ key. The first digit will start flashing. Scroll until the correct value appears in the first digit, then press the **yes** key. The second digit will start flashing. Scroll until the correct value appears in the second digit. Press the **yes** key. Continue in this manner until all digits have been correctly entered, then press the **yes** key to enter the value into the meter memory.

The display remains frozen for two seconds. Then P2 is displayed in the lower field indicating the meter is ready for the second buffer.

6. Rinse the electrode(s) and place into second buffer. When READY is displayed, indicating electrode stability, and the reading begins to flash, enter the correct value as described above.

The electrode slope is then displayed in the main field with SLP in the lower field. The meter automatically advances to measure mode.

7. Rinse the electrode(s) and place into sample. Record pH and temperature directly from the meter display.

Manual Calibration with One Buffer

1. Connect the electrode(s) to meter. Choose a buffer, which most closely approximates the expected sample pH. Rinse the electrode(s) and place into buffer.
2. Press the **mode** key until the pH mode indicator is displayed.
3. Press the **2nd** then the **cal** keys. CALIBRATE will be displayed above the main field and the time of the last calibration will be displayed. After a few seconds, P1 will be displayed in the lower field.
4. When READY is displayed, indicating electrode stability, and the reading begins to flash, press the ▲ or ▼ key. The first digit will start flashing. Scroll until the correct value appears in the first digit, the press the **yes** key. The second digit will start flashing. Scroll until the correct value appears in the second digit. Press the **yes** key. Continue in this manner until all digits have been correctly entered, then press the **yes** key to enter into the meter memory.
5. The P2 prompt will be displayed in the lower field. Press the **measure** key.
6. The slope prompt, SLP, will be displayed in the lower field and the electrode slope will be displayed in the main field. Press the **yes** key to enter the current electrode slope or scroll in a new value then press the **yes** key to enter into the meter memory.

The meter automatically advances to measure mode.
7. Rinse the electrode(s) and place into sample. Read sample pH directly from the meter display. Sample temperature is displayed in the lower field.

Millivolt Measurements

The Orion 230Aplus Meter can be used to measure absolute or relative millivolts. The millivolt modes are useful when performing potentiometric titrations or preparing calibration curves. Detailed instructions for any Orion electrode are given in the electrode instruction manual. ORP measurements and titration instructions are included in the Orion Redox Electrode (Orion 96-78 or 97-78) Instruction Manual, or in standard analytical chemistry texts.

Absolute Millivolts

Absolute millivolts are displayed with 0.1mV resolution in the range of -1600.0 to +1600.0 mV.

Access the absolute millivolt mode by pressing the **mode** key until the mV mode indicator is displayed.

Relative Millivolts

Relative millivolts are displayed with 0.1mV resolution over the range of -1999.9 to +1999.9 mV (absolute millivolt range of ± 1600.0).

Access the relative millivolt mode by pressing the **mode** key until the rel mV mode indicator is displayed.

Setting Relative Millivolt Offset

1. Press the **2nd** then the **cal** keys. CALIBRATE will be displayed and the current absolute millivolts will be displayed in the main field.
2. Once the signal is stable, the meter displays 0.0. Use the scroll keys to set the desired reading or leave the setting at 0.0. Press the **yes** key to enter the value into the meter memory. The meter automatically returns to MEASURE and all relative millivolt measurements will be based on the offset.

ORP Relative to Normal Hydrogen Electrode (NHE)

The sample's ORP millivolts correlate back to the Normal Hydrogen Electrode (NHE) when using Orion ORP Standard (Orion No. 967901 or 967961) and Orion ORP electrodes. ORP millivolts are displayed to 0.1mV resolution over the range of -1999.9 to +1999.9 mV.

Access the ORP millivolts mode by pressing the **mode** key until the E_H mode indicator is displayed. If E_H mode has not previously been calibrated then dashed lines "----" will be displayed.

Setting ORP Millivolt Offset

1. Press the **2nd** then the **cal** keys. CALIBRATE will be displayed and the current absolute mV will be displayed in the main field.

***NOTE:** If mV is not within the range of 220 ± 60 , an "E-21" error code will appear on display, alternating between the E-21 and the mV reading. This error code is a warning indicator. See **Troubleshooting** section for more details.*

2. Once meter is ready, relative millivolts of E_H will appear and will flash. Press **yes** to accept and **mode** to escape. The offset will be displayed for 1 to 2 seconds then the meter returns to the measurement mode.

F. Dissolved Oxygen Measurements

Dissolved oxygen measurements are displayed in ppm when the Orion 97-08 Dissolved Oxygen Electrode is used with the Orion 230Aplus Meter. Follow these instructions for preparing the meter and calibrating the electrode.

1. Connect the Orion 97-08 to meter and leave electrode mode switch "OFF".
2. Disconnect the ATC probe.
NOTE: ATC probe must not be connected to the meter.
3. Turn the HOLD feature (1-2) off.
4. Press the **measure** key. Using the **scroll** keys, change the temperature value to 25.0 °C.
5. Press the **cal** key. Enter the value 7.00 and press the **yes** key.
6. Press the **measure** key. The slope prompt, SLP, will be displayed in the lower field. Enter 100.0 and press the **yes** key. The meter will automatically enter measure mode.
7. Turn the mode switch on the electrode to BT CK. Good battery operation is indicated by a reading of 13.40 or greater on the meter.
8. Turn the mode switch on the electrode to ZERO. Use the zero calibration control to set the meter to read 0.00.
9. Insert the reservoir (funnel) into a BOD bottle containing enough water to just cover the bottom. Insert the electrode, making sure that the electrode tip is not immersed in the water and does not have water droplets clinging to the outside of the membrane. Let stand approximately 30 minutes to ensure water saturation of air in the BOD bottle. This bottle should be used for storage between measurements.
10. Turn the electrode mode switch to the AIR position. If measurements are being made at sea level use the AIR calibration control on the electrode to set the pH meter reading to the prevailing barometric pressure in mm Hg (divided by 100). If the barometric pressure is unknown, if the elevation is above sea level or if the sample has a salinity greater than 2 parts per thousand, consult Table 1 found in the Orion 97-08 Instruction Manual to obtain the correct AIR setting.
11. Turn the electrode mode switch to H₂O for sample analysis.

Chapter VI

Orion 250Aplus

A. Display

Operating Mode	Indicates instrument operating mode.
<i>SETUP</i>	<i>Indicates meter is in SETUP mode. Used to define operating parameters.</i>
<i>CALIBRATE</i>	<i>Indicates meter is in calibration mode, accessed by pressing 2nd then cal keys.</i>
<i>MEASURE</i>	<i>Indicates the meter is in measurement mode, accessed by pressing the measure key.</i>
Main Field	Displays pH, millivolts, relative millivolts, or E _H depending on the meter operating mode.
ON/OFF	Indicates if a particular feature is active or not in the SETUP menu.
Lower Field	Displays temperature in degrees Celsius. The °C designation is displayed when temperature is displayed.
ATC	Displayed when a temperature probe is attached.

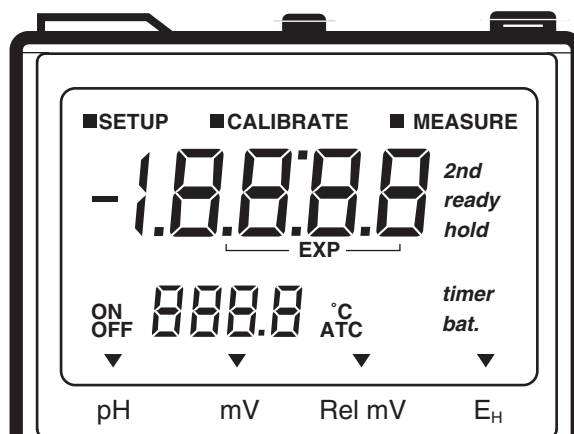

Figure 12: 250Aplus Display

2nd	Displayed when the 2nd key has been pressed, indicating the meter is ready to perform a secondary function.
READY	Displayed when the electrode signal is stable. The READY function may be turned on or off in the SETUP menu.
HOLD	Displayed when the pH reading is frozen after reaching stability in measure mode. The HOLD feature may be turned on or off in the SETUP menu.
TIMER	Displayed when the timer function has been activated.
BAT	Displayed when the battery is low and needs to be replaced.
Mode Indicator	Designates instrument measurement mode either pH, millivolts (mV), Relative millivolts (Rel mV) or ORP Relative to Normal Hydrogen Electrode (NHE).

B. Keypad

Primary Functions

yes	Press to enter a value during calibration or setup. May also be used to scroll through the setup menu without changing any parameters.
no	Press to cancel a change to a parameter before entering.
measure	Press for sample analysis. Instrument will remain in measure mode until another key is pressed. Press to unlock HOLD.
mode	Press to change measurement modes. The options are pH, mV, REL mV, or E _H .
2nd	Press to access second functions: cal, timer, setup or print.
▲	Press to increase value.
▼	Press to decrease value.
power	Press to turn meter on or off.

Second Functions

All second functions are accessed by first pressing the **2nd** key.

- cal** Press to start calibration. Meter automatically advances to measure mode after the calibration is complete.
- timer** Press to start the timer. When the preset time has elapsed, the instrument will beep for one minute (or until a key is pressed).
- print** Press to print display data
- setup** Press to access the setup menu. This is used for setting instrument operating parameters.

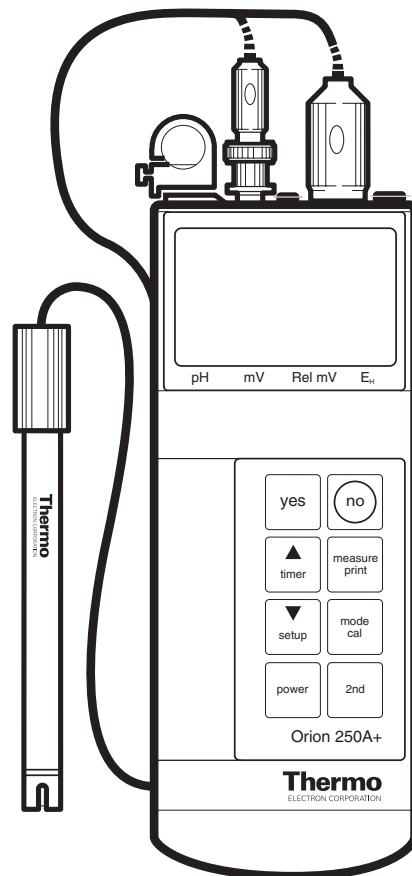

Figure 13: 250Aplus Keypad

C. Self Test and Checkout Procedure

1. Attach the BNC Shorting Plug (Orion No. 090045) to BNC connector on top of meter.
2. Press the **power** key to turn meter on.
3. If battery indicator remains on, replace battery or use line adapter.
4. Press the **power** key to turn meter off.
5. Press the **power** key and quickly press the **yes** key to start the self-test. (Alternatively, press and hold the **yes** key while pressing the **power** key). The instrument automatically performs electronic and hardware diagnostic tests. For a more detailed explanation, see the self-test section of the troubleshooting guide, page 81.
6. When the code 7 appears in the lower display field, “0” will be displayed, press each key, including the **power** key, one at a time. A numeric digit will be displayed upon each key press.

NOTE: All keys must be pressed within 10 seconds to complete test 7.
7. After the keypad test, the meter will turn off then back on again. After completing the self-test, the meter will resume normal operation.
8. If any problems are found during self-test, the meter will display the operator assistance code (for details, see page 83) until acknowledged by pressing the **yes** key.
9. Press the **measure** key. Main display should read a steady 7.00 ± 0.02 . If not, follow steps 9a through 9b.
 - a. Press the **cal** key, when the display flashes 7.00, press the **yes** key.
 - b. Press the **measure** key. The main display should read 100.0, with the legend SLP, in the lower display. If so, press the **yes** key. If not, scroll until the display reads 100.0. Then press the **yes** key. The meter advances to measure and the display should now read a steady 7.00.
10. Press the **mode** key to enter millivolt mode. 0.0 ± 0.1 should be displayed. If not, reseal the shorting cap and repeat steps 4 through 10.
11. Press the **mode** key to enter REL mV mode. 0.0 ± 0.1 should be displayed. If not, press the **2nd** then the **cal** keys. Then press the **yes** key to enter the value 0.0. Display should read a steady 0.0.
12. After steps 9 through 11 have been successfully completed, the meter is ready for use with electrodes. Remove the shorting plug.

D. SETUP Menu

The SETUP menu is used to identify and change instrument operating parameters. In setup, the **yes** key is used to scroll through the menu without changing any parameters. To change a parameter, press one of the scroll keys, **▲** or **▼**, then press the **yes** key to enter the change into the meter memory. Press the **no** key to restore the parameter to its former state (if done before entering the new parameter).

To enter the SETUP menu, press the **2nd** then the **setup** keys. 1-1 and READY will be displayed. The ON or OFF indicator flashes indicating the current status. Press the **yes** key to accept and continue through the menu. Press a scroll key, **▲** or **▼**, to change. After changing a setting, press the **yes** key to enter the change into the meter memory.

To change a numeric value, press the **▲** or **▼** key, the first digit will start flashing. Scroll until the first digit is the desired value. Then press the **yes** key. The second digit will flash, scroll until the desired value is displayed. Then press the **yes** key. Continue in this manner until all digits have been changed to the desired value. Then press the **yes** key to enter the new value into the meter memory.

Scroll through the SETUP menu accepting or changing parameters as desired.

To exit the SETUP menu, press the **2nd** then the **cal** keys to begin the calibration sequence or press the **measure** key to analyze samples.

The following parameters are accessed in the setup menu.

- | | |
|-----------|--|
| 1-1 READY | Turning READY on will cause the ready indicator to be displayed when the electrode signal is stable. The default setting is on. |
| 1-2 HOLD | Turning HOLD on will cause the display to freeze during sample measurements when the electrode signal is stable. Press the measure key to unlock the hold and returns the meter to live displays during sample measurement. The default setting is off. |
| 1-3 BEEP | Turning BEEP on will cause an audible signal to sound on ready, when a key is pressed and when an operator assistance code appears. The default setting is on. |

- 1-4 AUTO-SHUTOFF Turning AUTOSHUTOFF on will cause the meter to turn off if no keys have been pressed for 10 minutes. This feature will save battery life. The default setting is on.
- 2-1 SLOPE Allows review of electrode slope in memory at any time. The slope value cannot be changed in the setup menu.
- 2-2 RESOLUTION Allows selection of either 0.1 or 0.01 pH resolution. Press a scroll (▲ or ▼) key to change the resolution. Then press the **yes** key to enter and continue through the menu. The default setting is 0.01.
- 2-3 ISOPOTENTIAL POINT Use to change the isopotential point for a particular pH electrode. In pH mode, the default value is 7.00.
- 2-4 RESET Sets all the calibration data and setup options to factory default values. This is particularly useful during trouble shooting or starting with a fresh electrode. To RESET press the ▲ scroll key, the ON will flash and the beeper will ring rapidly. Press the **yes** key to reset. Press the **no** key to cancel.

***NOTE:** Setup functions 2-1 Slope, 2-2 Resolution, and 2-3 Isopotential Point are only accessed in pH mode.*

- 3-1 TIMER INTERVAL Used to set the timer interval. The maximum interval that can be set is 23 hours, 59 minutes, and 59 seconds. The minimum interval is five (5) seconds. When the TIMER INTERVAL code, 3-1, is displayed the current interval hours setting is displayed in the main field (H 00). Press the **yes** key to accept or scroll to change, then press the **yes** key. Next, the current interval minutes:seconds will be displayed (00:00). Press the **yes** key to accept current setting or scroll to desired value then press the **yes** key to accept. The default setting is five (5) seconds.
- 3-2 TIME REMAINING Allows review of the time remaining before the TIMER is set to go off.

- 3-3 SET REAL TIME Used to set the actual time of day. The meter uses a 24-hour clock. When the code 3-3 is displayed in the lower field, the current time (hours: minutes) is displayed in the main field. If correct, press the **yes** key to accept. Otherwise, change as required then press the **yes** key to accept the new time.
- 3-4 SET DATE Used to set the current date. When the code 3-4 is displayed in the lower field, the current date (month:day) is displayed in the main field. Press the **yes** key to accept or change the date as needed then press the **yes** key to accept. Next, the current year is displayed. Press the **yes** key to accept or change as required then press the **yes** key to accept.
- 5-1 PRINT MODE When 5-1 is displayed in the lower field, the current print mode is displayed in the main field. The options are:
- 1-Manual Print, indicates no automatic output to the printer. The user may print on command by pressing the **2nd** then **print** keys;
 - 2-Print on Ready, the meter will send information to the printer whenever the electrode signal reaches stability;
 - 3-Print on a timed interval, printing occurs at a preset timed interval.
- Use the scroll keys to change the setting, then press the **yes** key to enter the new setting into meter memory. The default setting is 1; print on command.
- 5-2 SET PRINT INTERVAL Used to set the timed print interval. The maximum print interval is 23 hours, 59 minutes and 59 seconds. The minimum print interval is 5 seconds. When the code 5-2 is displayed in the lower field, the current print interval hours will flash in the main display. Press the **yes** key to accept or change using the scroll keys. Then press the **yes** key to enter. Next, the print interval minutes:seconds will be displayed in the main field. Press the **yes** key to accept or change, then press the **yes** key to enter the new setting into the meter memory. The default setting is 1 minute.

E. Calibration and Measurement Procedures

pH Measurements

A one or two buffer calibration should be performed before pH is measured. It is recommended that a two buffer calibration, using buffers that bracket the expected sample range, be performed at the beginning of each day to determine the slope of the electrode. This serves the dual purpose of determining if the electrode is working properly and storing the slope value in the memory. Perform a one buffer calibration every two hours to compensate for electrode drift.

Prior to calibration, scroll through the SETUP menu and ensure all parameters are set properly for the analysis you want to perform. Select the desired resolution and verify that the isopotential point is set correctly for the electrode.

There are two ways of calibrating the 250Aplus Meter: autocalibration or manual calibration. Following are descriptions and instructions for each method.

Autocalibration

Autocalibration is a feature of the Orion 250Aplus Meter that automatically recognizes the buffers 7.00, 4.01 and 10.01 with a range of ± 0.5 pH units. During calibration, the user waits for a stable pH reading. Once the electrode is stable, the meter automatically recognizes and displays the temperature-corrected value for that buffer. Press the **yes** key to enter the value into the meter memory.

***NOTE:** Do not scroll when using autocalibration.*

The 250Aplus Meter compares actual values to theoretical values to determine if the buffer is within range. Results greater than ± 0.5 pH units from the correct value will trigger an operator assistance code. For best results, it is recommended that an ATC probe be used. If an ATC probe is not used all samples and buffers should be at the same temperature or manual temperature compensation should be used.

Autocalibration with Two and Three Buffers

1. Connect the electrode(s) to meter.

For 2-point Cal: Choose either 4.01 and 7.00 or 7.00 and 10.01 buffers, whichever bracket your expected sample range.

For 3-point Cal: Choose 4.01, 7.00 and 10.01 buffers

2. Press the **mode** key until the pH mode indicator is displayed.
3. Rinse the electrode(s) and place into the first buffer.
4. Press the **2nd** then the **cal** keys. CALIBRATION is displayed above the main field and the time and date of the last calibration are displayed. After a few seconds, P1 is displayed in lower field. P1 indicates that the meter is ready for the first buffer and a value has not yet been entered. When READY is displayed, indicating electrode stability, the reading begins to flash, press the **yes** key. The display will remain frozen for two seconds. Then P2 will be displayed in the lower field indicating that the meter is ready for the second buffer.

For 2-point Cal: Rinse the electrode(s) and place into the second buffer. When READY is displayed, press the **yes** key. Press the **measure** key to end calibration at two points. SLP appears in the lower field with the actual electrode slope, in percent, in the field.

For 3-point Cal: Rinse the electrode(s) and place into the third buffer. When READY is displayed, press the **yes** key. After the third buffer value has been entered, the electrode slope will be displayed. SLP appears in the lower field with the actual electrode slope, in percent, in the main field.

The meter automatically advances to the measure mode. MEASURE is displayed above the main field.

5. Rinse the electrode(s) and place into sample. Record pH directly from the meter display and temperature from the lower field.

Autocalibration with One Buffer

1. Connect the electrode(s) to meter. Select one buffer, either 4.01, 7.00 or 10.01, whichever most closely approximates the expected sample pH.
2. Press the **mode** key until the pH mode indicator is displayed.
3. Rinse the electrode(s) and place into the buffer and press the **2nd** then the **cal** keys. CALIBRATE will be displayed above the main field and the time and date of the last calibration will be displayed. After a few seconds, P1 will be displayed in the lower field.
4. When READY is displayed, indicating electrode stability, and the reading begins to flash, press the **yes** key. The display remains frozen for two seconds. Then P2 is displayed in the lower field.
5. Press the **measure** key. SLP will be displayed in the lower field and the electrode slope in memory in the main field. If necessary, enter the correct electrode slope determined by a two point calibration and press the **yes** key. If slope value is unknown, enter 100.0 or perform a two buffer calibration.
6. Rinse the electrode(s) and place into sample. Read the pH directly from the main display and temperature from the lower field.

Manual Calibration

To calibrate with buffers other than 4.01, 7.00 or 10.01, use the manual calibration technique. The calibration sequence is the same as autocalibration except buffer values are manually entered using the scroll keys.

For best results, it is recommended that an ATC probe be used. If an ATC probe is not used, all samples and standards should be at the same temperature or manual temperature compensation should be used. See page 79.

Manual Calibration with Two or Three Buffers

1. Connect the electrode(s) to meter. Choose two or three buffers that will bracket your expected sample range.
2. Press the **mode** key until the pH mode indicator is displayed.
3. Rinse the electrode(s) and place into the first buffer.
4. Press the **2nd** then the **cal** keys. CALIBRATE will be displayed above the main readout and the time of the last calibration will be displayed. After a few seconds, P1 will be displayed in the lower field.
5. When READY is displayed, indicating electrode stability, and the reading begins to flash, press the **▲** or **▼** key. The first digit will start flashing. Scroll until the correct value appears in the first digit, then press the **yes** key. The second digit will start flashing. Scroll until the correct value appears in the second digit. Press the **yes** key. Continue in this manner until all digits have been correctly entered, then press the **yes** key to enter the value into the meter memory.

The display remains frozen for two seconds. Then P2 is displayed in the lower field indicating the meter is ready for the second buffer.

6. Rinse the electrode(s) and place into second buffer. When READY is displayed, the reading will begin to flash, enter the correct value as described above. P3 prompt will display in the lower field indicating the meter is ready for the third buffer.
7. Rinse the electrode(s) and place into the third buffer. When READY is displayed, indicating electrode stability, and the reading begins to flash, enter the correct value as described above.

The average electrode slope is then displayed in the main field with SLP in the lower field. The meter automatically advances to measure mode.

8. Rinse the electrode(s) and place into sample. Record pH and temperature directly from the meter display.

Manual Calibration with One Buffer

1. Connect the electrode(s) to meter. Choose a buffer, which most closely approximates the expected sample pH. Rinse the electrode(s) and place into buffer.
2. Press the **mode** key until the pH mode indicator is displayed.
3. Press the **2nd** then the **cal** keys. CALIBRATE will be displayed above the main field and the time of the last calibration will be displayed. After a few seconds, P1 will be displayed in the lower field.
4. When READY is displayed, indicating electrode stability, and the reading begins to flash, press the **▲** or **▼** key. The first digit will start flashing. Scroll until the correct value appears in the first digit, the press the **yes** key. The second digit will start flashing. Scroll until the correct value appears in the second digit. Press the **yes** key. Continue in this manner until all digits have been correctly entered, then press the **yes** key to enter into the meter memory.
5. The P2 prompt will be displayed in the lower field. Press the **measure** key.
6. The slope prompt, SLP, will be displayed in the lower field and the electrode slope will be displayed in the main field. Press the **yes** key to enter the current electrode slope or scroll in a new value then press the **yes** key to enter into the meter memory.
The meter automatically advances to measure mode.
7. Rinse the electrode(s) and place into sample. Read sample pH directly from the meter display. Sample temperature is displayed in the lower field.

Millivolt Measurements

The Orion 250Aplus Meter can be used to measure absolute or relative millivolts. The millivolt modes are useful when performing potentiometric titrations or preparing calibration curves. Detailed instructions for any Orion electrode are given in the electrode instruction manual. ORP measurements and titration instructions are included in the Orion Redox Electrode (Orion 96-78 or 97-78) Instruction Manual, or in standard analytical chemistry texts.

Absolute Millivolts

Absolute millivolts are displayed with 0.1mV resolution in the range of -1600.0 to +1600.0 mV.

Access the absolute millivolt mode by pressing the **mode** key until the mV mode indicator is displayed.

Relative Millivolts

Relative millivolts are displayed with 0.1mV resolution over the range of -1999.9 to +1999.9 mV (absolute millivolt range of ± 1600.0).

Access the relative millivolt mode by pressing the **mode** key until the rel mV mode indicator is displayed.

Setting Relative Millivolt Offset

1. Press the **2nd** then the **cal** keys. CALIBRATE will be displayed and the current absolute millivolts will be displayed in the main field.
2. Once the signal is stable, the meter displays 0.0. Use the scroll keys to set the desired reading or leave the setting at 0.0. Press the **yes** key to enter the value into the meter memory. The meter automatically returns to MEASURE and all relative millivolt measurements will be based on the offset.

ORP Relative to Normal Hydrogen Electrode (NHE)

The sample's ORP millivolts correlate back to the Normal Hydrogen Electrode (NHE) when using Orion ORP Standard (Orion No. 967901 or 967961) and Orion ORP electrodes. ORP millivolts are displayed to 0.1mV resolution over the range of -1999.9 to +1999.9 mV.

Access the ORP millivolts mode by pressing the **mode** key until the E_H mode indicator is displayed. If E_H mode has not previously been calibrated then dashed line "----" will be displayed.

Setting ORP Millivolt Offset

1. Press the **2nd** then the **cal** keys. CALIBRATE will be displayed and the current absolute mV will be displayed in the main field.

***NOTE:** If mV is not within the range of 220 ± 60 , an "E-21" error code will appear on display, alternating between the E-21 and the mV reading. This error code is a warning indicator. See **Troubleshooting** section for more details.*

2. Once meter is ready, relative millivolts of E_H will appear and will flash. Press **yes** to accept and **mode** to escape. The offset will be displayed for 1 to 2 seconds then the meter returns to the measurement mode.

F. Dissolved Oxygen Measurements

Dissolved oxygen measurements are displayed in ppm when the Orion 97-08 Dissolved Oxygen Electrode is used with the Orion 250Aplus Meter. Follow these instructions for preparing the meter and calibrating the electrode.

1. Connect the Orion 97-08 to meter and leave electrode mode switch "OFF".
2. Disconnect the ATC probe.
NOTE: ATC probe must not be connected to the meter.
3. Press the **mode** key until the pH mode indicator is displayed.
4. Turn the hold feature (1-2) off.
5. Press the **measure** key. Using the **scroll** keys, change the temperature value to 25.0 °C.
6. Press the **2nd** then the **cal** keys. Enter the value 7.00 and press the **yes** key.
7. Press the **measure** key. The slope prompt, SLP, will be displayed in the lower field. Enter 100.0 then press the **yes** key. The meter automatically enters the measure mode.
8. Turn the mode switch on the electrode to BT CK. Good battery operation is indicated by a reading of 13.40 or greater on the meter.
9. Turn the mode switch on the electrode to ZERO. Use the zero calibration control to set the meter to read 0.00.
10. Insert the reservoir (funnel) into a BOD bottle containing enough water to just cover the bottom. Insert the electrode, making sure that the electrode tip is not immersed in the water and does not have water droplets clinging to the outside of the membrane. Let stand approximately 30 minutes to ensure water saturation of air in the BOD bottle. This bottle should be used for storage between measurements.
11. Turn the electrode mode switch to the AIR position. If measurements are being made at sea level, use the AIR calibration control on the electrode to set the pH meter reading to the prevailing barometric pressure in mm Hg (divided by 100). If the barometric pressure is unknown, if the elevation is above sea level or if the sample has a salinity greater than 2 parts per thousand, consult Table 1 found in the Orion 97-08 Instruction Manual to obtain the correct AIR setting.
12. Turn the electrode mode switch to H₂O for sample analysis.

Chapter VII

Orion 290Aplus

A. Display

Operating Mode	Indicates instrument operating mode.
<i>SETUP</i>	<i>Indicates meter is in setup mode. Used to define operating parameters.</i>
<i>CALIBRATE</i>	<i>Indicates meter is in calibration mode. Accessed by pressing the 2nd then the cal keys.</i>
<i>MEASURE</i>	<i>Indicates meter is in measurement mode. Accessed by pressing the measure key.</i>
Main Field	Displays pH, millivolts, relative millivolts or concentration depending on the meter measurement mode.
ON/OFF	During SETUP, on/off indicates if a particular feature is active or not.
Lower Field	Displays temperature in degrees Celsius. The °C designation is displayed when temperature is displayed.
ATC	Displayed when a temperature probe is attached.

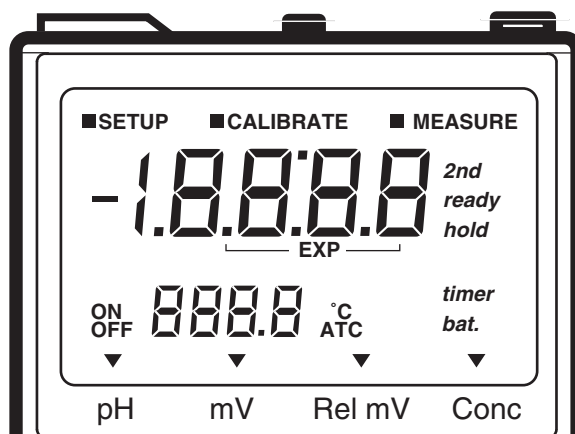

Figure 14: 290Aplus Display

2nd	Displayed when the 2nd key has been pressed, indicating the meter is ready to perform a secondary function.
READY	Displayed when the electrode is stable. READY may be turned on or off in the SETUP menu.
HOLD	Displayed when the reading is frozen after reaching stability. The HOLD feature may be turned on or off in the SETUP menu.
TIMER	Displayed when the timer function has been activated.
BAT.	Displayed when the battery is low and needs to be replaced.
Mode Indicator	Designates instrument operating mode either pH, millivolts (mV), Relative millivolts (Rel mV), or Concentration (conc).

B. Keypad

Primary Functions

yes	Press to enter a value during calibration or setup. May also be used to scroll through the setup menu without changing any parameters.
no	Press to cancel a change to a parameter before entering.
measure	Press for sample analysis. Instrument will remain in measure mode until another key is pressed. Press to unlock hold during sample analysis.
mode	Press to change operating mode. The options are pH, mV, REL mV or Concentration.
2nd	Press to access second functions: cal, timer, setup, or print.
▲	Press to increase value
▼	Press to decrease value.
power	Press to turn meter on or off.

Second Functions

All second functions are accessed by first pressing the **2nd** key.

- cal** Press to start calibration
- timer** Press to start the timer. When the preset time has elapsed, the instrument will beep for 1 minute (or until a key is pressed)
- setup** Press to access the setup menu. This is used for setting instrument operating parameters.
- print** Press to print current display data and/or to enter data into the internal datalogger. Selection of either option or both can be made in the setup menu. At the end of each calibration, all data is printed automatically. Pressing print during calibration will cause data from the previous cal to be printed until the calibration sequence is completed.

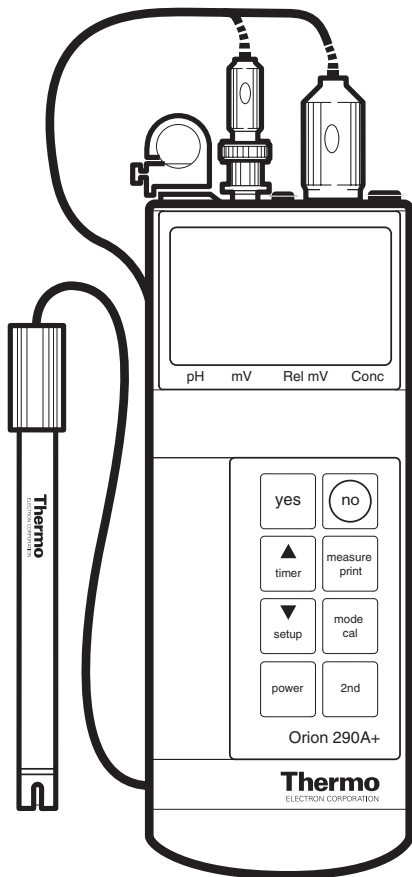

Figure 15: 290Aplus Keypad

C. Self Test and Checkout Procedure

1. Attach the BNC Shorting Plug (Orion No. 090045) to BNC connector on top of meter.
2. Press the **power** key to turn meter on.
3. If battery indicator remains on, replace battery or use line adapter.
4. Press the **power** key to turn meter off.
5. Press the **power** key and quickly press the **yes** key to start the self-test. (Alternatively, press and hold the **yes** key while pressing the **power** key). The instrument automatically performs electronic and hardware diagnostic tests. For a more detailed explanation, see the self-test section of the troubleshooting guide page 85.
6. When the code 7 appears in the lower display field, "0" will be displayed, press each key, including the **power** key, one at a time. A numeric digit will be displayed upon each key press.

NOTE: All keys must be pressed within 10 seconds to complete test 7.

7. After the keypad test, the meter will turn off then back on again. After completing the self-test, the meter will resume normal operation.
8. If any problems are found during self-test, the meter will display the operator assistance code until acknowledged by pressing the **yes** key in **Troubleshooting** section.
9. Press the **measure** key. Main display should read a steady 7.00 ± 0.02 . If not, follow steps 9a through 9b.
 - a. Press the **cal** key, when the display flashes 7.00, press the **yes** key.
 - b. Press the **measure** key. The main display should read 100.0, with the legend SLP, in the lower display. If so, press the **yes** key. If not, scroll until the display reads 100.0. Then press the **yes** key. The meter advances to measure and the display should now read a steady 7.00.

10. Press the **mode** key to enter millivolt mode. 0.0 ± 0.1 should be displayed. If not, reseal the shorting cap and repeat steps 4 through 10.
11. Press the **mode** key to enter REL mV mode. 0.0 ± 0.1 should be displayed. If not, press the **2nd** then the **cal** keys. Then press the **yes** key to enter the value 0.0. Display should read a steady 0.0.
12. Press the mode key until the concentration mode indicator is displayed. Display should read 1.00. If not, press the **2nd** then the **cal** keys.
 - a. At the P1 prompt, press the **yes** key to enter 1.00.
 - b. Press the **measure** key. SLP and 59.2 should be displayed. If so, press the **yes** key. If not, enter 59.2, then press the **yes** key. Meter automatically returns to measure mode. Display should read a steady 1.00.
13. After steps 9 through 12 have been successfully completed, the meter is ready for use with electrodes. Remove the shorting plug.

D. SETUP Menu

The SETUP menu is used to identify and change instrument operating parameters. While in setup, the **yes** key is used to scroll through the menu without changing any parameters.

To enter the SETUP menu, press the **2nd** then the **setup** keys. 1-1 and READY will be displayed. The ON or OFF indicator flashes indicating the current status. Press the **yes** keys to accept and continue through the menu. Press a scroll key, **▲** or **▼**, to change. After changing a setting, press the **yes** key to enter. Press the **no** key to restore the parameter to its former state (if done before entering the new setting).

To change a numeric value, press the **▲** or **▼** key. The first digit will start flashing. Scroll until the first digit is the desired value. Then press the **yes** key. The second digit will flash. Scroll until the desired value is displayed. Then press the **yes** key. Continue in this manner until all digits have been changed. Then press the **yes** key to enter the new value.

Scroll through the SETUP menu accepting or changing parameters as desired. To exit the SETUP menu, press the **2nd** then the **cal** keys to begin the calibration sequence or press the **measure** key to analyze samples.

The following parameters are accessed in the SETUP menu.

- | | |
|------------------|---|
| 1-1 READY | Turning READY on will cause the ready indicator to be displayed when the electrode signal is stable. The default setting is on. |
| 1-2 HOLD | Turning HOLD on will cause the display to freeze during sample measurements when the electrode signal is stable. The default setting is off. Press the measure key to unlock HOLD during analysis. |
| 1-3 BEEP | Turning BEEP on will cause an audible signal to sound on ready, when a key is pressed, and when an operator assistance code occurs. The default setting is on. |
| 1-4 AUTO-SHUTOFF | Turning AUTOSHUTOFF on will cause the meter to turn off if no keys have been pressed for 10 minutes. This feature will save battery life. The default setting is on. |

- 2-1 SLOPE Allows review of electrode slope in memory at any time. Value cannot be changed in the setup menu.
- 2-2 RESOLUTION Allows selection of resolution. For pH choose from 0.1 to 0.01 to 0.001. Press a scroll key (▲ or ▼) to change the resolution. Then press the **yes** key to enter and continue through the menu. In Concentration mode, select 1, 2 or 3 significant digits. Example: press a scroll key (▲ or ▼) to change the concentration value from 19900 → 19000 → 1000 → 19900. Select the number of digits desired. Then press the **yes** key to enter. The default setting is .001 for pH and 3 digits for concentration.
- 2-3 ISOPOTENTIAL POINT Use to change the isopotential point for a particular pH electrode. In pH mode, the default value is 7.000. The isopotential point may not be changed in any other mode.
- 2-4 RESET Allows all the setup options and calibration data to be set to factory default values. This is particularly useful during troubleshooting or prior to calibrating with a new electrode. To RESET, press the ▲ scroll key, the ON will flash and the audio signal will ring rapidly. Press the **yes** key to reset.

***NOTE:** Setup function 2-3 Isopotential Point is only accessible in pH mode. SETUP Functions 2-1 Slope and 2-2 Resolution are only accessible in pH and concentration modes.*

- 3-1 TIMER INTERVAL Used to set the timer interval. The maximum interval that can be set is 23 hours, 59 minutes and 59 seconds. The minimum interval is five (5) seconds. When the TIMER INTERVAL code (3-1), is displayed, the current interval hours setting will be displayed in the main field. Press the **yes** key to accept or scroll (▲ or ▼) keys to change then press the **yes** key to accept. Next, the current interval minutes:seconds will be displayed. Press the **yes** key to accept current setting or use the scroll (▲ or ▼) keys to change to the desired value then press the **yes** key to accept. The default setting is five (5) seconds.

3-2 REMAINING TIME	Shows time remaining before timer is set to ring.
3-3 SET REAL TIME	Used to set the time of day. The meter uses a 24 hour clock. When the code 3-3 is displayed in the lower field, the current time (hours:minutes) will be displayed in the main field. If correct, press the yes key to accept. Otherwise, change as required and press the yes key to accept.
3-4 SET DATE	Used to set the current date. When the code 3-4 is displayed in the lower field, the current date (month:day) is displayed in the main field. Press the yes key to accept or change the date as needed then press the yes key to enter the new date.
4-H HIGH ALARM LIMIT	Used to set the high alarm limit for the current measurement mode. When the reading exceeds the set limit, the alarm will ring. The maximum limits are 19.999 for pH, 19900 for concentration, +1600.0 mV and +1999.9 relative millivolts. To change the current setting, use the scroll (▲ or ▼) keys then press the yes key to enter into the meter memory.
4-L LOW ALARM LIMIT	Used to set the low alarm limit for the current measurement mode. When the reading falls below the set limit, the alarm will ring. The minimum limits are -2.000 pH, 0.0 for Concentration, -1600.0 mV, and -1999.9 for relative millivolts. To change the low limit, use the scroll (▲ or ▼) keys then press the yes key to enter into the meter memory.
5-1 PRINT MODE	<p>Sets the print mode. When 5-1 is displayed in the lower field, the current print mode will flash in the main field. The options are:</p> <ol style="list-style-type: none"> 1. Manual Print, indicates no automatic output to the printer and the user may print on command by pressing the 2nd then the print key; 2. Print on READY, the meter will send information to the printer whenever the electrode signal is stable;

3. Print on a timed interval, printing occurs at user selected timed intervals.

Use the scroll (▲ or ▼) keys to change the setting. Then press the yes key to enter the new setting. The default setting is 1 PRINT on command.

5-2 SET PRINT INTERVAL

Used to set the timed print interval. The maximum print interval is 23 hours, 59 minutes and 59 seconds. The minimum print interval is five (5) seconds. When the code 5-2 is displayed in the lower field, the current print interval hours will flash in the main display indicated by an H in the left most position. Press the **yes** key to accept or change using the ▲ or ▼ keys then press the **yes** key to enter. Next, the print interval minutes: seconds will be displayed in the main field. Press the **yes** key to accept or change, then press the **yes** key to enter the new setting. The default setting is (1) one minute.

6-1 DATALOG MODE

Sets the datalogger mode. Up to 25 points may be stored in memory at any one time. The four options are:

0. Off, when 0 is selected, no datalogging of any kind will occur;
1. Manual datalog, no automatic output to the datalogger will occur, the user must press the **2nd** then the **print** keys to log data;
2. Datalog on ready, datalogging occurs when the electrode signal is stable (on ready);
3. Timed datalog, datalogging occurs at a preset timed interval.

When the code 6-1 is displayed in the lower field, the current datalogger mode will flash in the main display. Use the scroll (▲ or ▼) keys to change, then press the **yes** key to enter the new choice. The default setting is 0 OFF.

- 6-2 DATALOG INTERVAL Sets the timed datalogger interval. The maximum interval is 23 hours, 59 minutes and 59 seconds. The minimum interval is five (5) seconds. When the code 6-2 is displayed in the lower field, the current datalogger interval hours are displayed in the main field indicated by an H in the left position. Use the scroll (▲ or ▼) keys to change the setting, then press the **yes** key to enter. Next, the current datalogger interval minutes:seconds will be displayed in the main field. Use the scroll (▲ or ▼) keys to change the setting, then press the **yes** key to enter. The default setting is (5) seconds.
- 6-3 TRANSFER DATA Use this setting to transfer data from the datalogger to a printer or a computer. When the code 6-3 is displayed, the OFF will flash. To transfer the data, press a scroll (▲ or ▼) key until ON is displayed. Then press the **yes** key. Once the data has been transferred, the meter advances to the next setup option.
- NOTE:** Down loading the data does not clear the memory. To clear memory, see step 6-4 below.*
- 6-4 CLEAR DATA This function clears all data from the datalogger memory. When the code 6-4 is displayed, the OFF will flash. To clear the data, press a scroll (▲ or ▼) key until ON is displayed. The alarm will ring rapidly to indicate the memory is about to be erased. Press the **yes** key to clear.

E. Calibration and Measurement Procedures

pH Measurements

The Orion 290Aplus can perform up to a five (5) point pH calibration. Either autocalibration, manual calibration or a combination of the two may be used.

A one, two, or multi-point calibration should be performed using fresh buffers before pH is measured. It is recommended that a minimum of a two-point calibration, using buffers that bracket the expected sample range, be performed at the beginning of each day to determine the slope of the electrode. This serves the dual purpose of determining if the electrode is working properly and storing the slope value in memory. Perform a one buffer calibration every two hours to compensate for electrode drift. Use a fresh aliquot of one of the calibration buffers.

***NOTE:** If a three or more point calibration is being used, recalibrate using all buffers.*

Prior to calibration, scroll through the setup menu and ensure all parameters are set properly for the analysis you want to perform. Select the resolution desired and verify the isopotential point is set correctly for the electrode.

There are two ways of calibrating the 290Aplus Meter: autocalibration or manual calibration. Following are descriptions and instructions for each method.

Autocalibration

Autocalibration is a feature of the Orion 290Aplus Meter that automatically recognizes five buffers (1.68, 4.01, 7.00, 10.01 and 12.46) within a range of ± 0.5 pH units. During calibration, the user waits for a stable pH reading. Once the electrode is stable, the meter automatically recognizes and displays the temperature-corrected value for that buffer. Press the **yes** key to enter the value into memory.

***NOTE:** Do not scroll when using autocalibration.*

The 290Aplus Meter compares actual values to theoretical values to determine if the buffer is within range. Results greater than ± 0.5 pH units from the correct value will trigger an operator assistance code. For best results, it is recommended that an ATC probe be used. If an ATC probe is not used, all samples and buffers should be at the same temperature or use manual temperature compensation.

Manual Calibration

To calibrate with buffers other than 1.68, 4.01, 7.00, 10.01 or 12.45, use the manual calibration technique. The calibration sequence is the same as autocalibration except that buffer values are scrolled in. To enter a value, press the ▲ or ▼ key. The first digit will flash, continue to press the scroll (▲ or ▼) key until the desired value is displayed. Press the **yes** key to accept. Continue for each digit. When the correct buffer value is displayed, press the **yes** key to accept.

***NOTE:** For manual calibration, you must use the scroll keys. Otherwise, the meter assumes you are performing an autocalibration. Even if the buffer value is correct, you must press a scroll (▲ or ▼) key to start the editing process. Then press the **yes** key to accept each digit.*

For best results, it is recommended that an ATC probe be used. If an ATC probe is not used, all samples and standards should be at the same temperature or manual temperature compensation should be used.

Multipoint pH Calibration

Up to a five (5) point calibration can be performed on the 290Aplus. Both autocalibration and manual calibration may be used within the same calibration curve. For example, autocalibration may be used with the 1.68, 7.00 and 10.01 buffers while manual calibration would be used with 3.78 and 9.18 buffers.

The instrument uses a point to point calibration scheme, i.e. the meter stores the different electrode slopes for each portion of the calibration curve in memory. When measuring in a particular region of the curve, the electrode slope for that region is employed in the calculation of sample pH. The electrode slope displayed after calibration is an average slope for all the segments of the entire calibration curve. Use of this scheme increases accuracy in the different regions of the calibration curve. However, the electrode slope may be lower than normal, especially if buffers from the pH extremes <2.00 or >12.00 are used.

It is recommended that automatic temperature compensation be used. If not, all buffers and samples should be at the same temperature or manual temperature compensation should be used.

Two or More Buffer Calibration

Prior to calibration, set the resolution to the desired level, check the isopotential point, and change any parameters in the setup menu.

1. Select and prepare the buffers to be used. A maximum of five buffers may be used.
2. Press the **mode** key until the pH mode indicator is displayed.
3. Rinse the electrode(s) and place into the first buffer.
4. Press the **2nd** then the **cal** keys. CALIBRATE and the time and date of the last calibration will be displayed. After a few seconds, P1 will be displayed in the lower field indicating the meter is ready for the first buffer.
5. When READY is displayed, indicating electrode stability, press the **yes** key, if using autocalibration. If not, manually enter the value using the scroll (**▲** or **▼**) keys then press the **yes** key. To enter a value, press the **▲** or **▼** key. The first digit will flash, continue to press the scroll (**▲** or **▼**) key until the desired value is displayed, then press the **yes** key to accept. Continue for each digit. When the correct buffer value is displayed then press **yes** key to enter into the meter memory.
6. The P2 prompt is then displayed for the second buffer.
7. Rinse the electrode(s) and place into second buffer. When READY is displayed, indicating electrode stability, enter the correct buffer value as above. Then press the **yes** key to enter into the meter memory.
8. The P3 prompt for the third buffer will be displayed.
9. Repeat step 7 until all the buffers have been entered. If using less than five buffers, press the **measure** key once all the buffers you are using have been entered. The electrode slope will then be displayed with the prompt SLP in the lower field. If using five buffers, the meter automatically advances to the measure mode once the buffers have been entered.
10. Rinse the electrode(s) and place into sample. Record pH and temperature directly from the meter display.

One Buffer Calibration

1. Connect the electrode(s) to meter. Choose a buffer that most closely approximates the expected sample pH. Rinse the electrode(s) and place into buffer.
2. Press the **mode** key until the pH mode indicator is displayed
3. Press the **2nd** then the **cal** keys. CALIBRATE and the time and date of the last calibration will be displayed. After a few seconds, P1 will be displayed in the lower field.
4. When READY is displayed, indicating electrode stability, press the **yes** key, if using autocalibration. If not, manually enter the value using the scroll (**▲** or **▼**) keys then press the **yes** key. To enter a value, press the **▲** or **▼** key. The first digit will flash, continue to press the scroll (**▲** or **▼**) key until the desired value is displayed, then press the **yes** key to accept. Continue for each digit. When the correct buffer value is displayed then press **yes** key to enter into the meter memory.
5. The P2 prompt will be displayed in the lower field. Press the **measure** key.
6. The slope prompt, SLP, will now be displayed in the lower field and the electrode slope will be displayed in the main field. Press the **yes** key to enter the current electrode slope or scroll in a new value then press the **yes** key. The meter automatically advances to measure mode
7. Rinse the electrode(s) and place into sample. Read sample pH directly from the meter display. Sample temperature is displayed in the lower field.

Concentration Measurements

A one, two or multi-point calibration should be performed before concentration is measured. It is recommended that a two-point standard calibration be performed at the beginning of each day and every time electrodes are changed, to determine the slope of the electrode. This serves the dual purpose of determining if the electrode is working properly and storing the slope value into memory. Perform a calibration with one standard every two hours to compensate for possible electrode drift. Use a fresh aliquot of one of the standards used for calibration.

NOTE: When calibrating with three or more standards, repeat the calibration using fresh aliquots of all standards.

During calibration, always use the most dilute standard first. The 290Aplus will automatically recognize slope direction (i.e. will recognize anion or cation electrodes).

Up to a five point calibration may be performed on the 290Aplus. The instrument uses a point to point calibration scheme, i.e. the meter stores the different electrode slopes for each portion of the calibration curve in memory. When measuring in a particular region of the curve, the electrode slope for that region is employed in the calculation of sample concentration. The electrode slope displayed after calibration is the average slope for all the segments of the entire calibration curve. Use of this scheme increases accuracy in the different regions of the calibration curve. However, the electrode slope may be lower than normal, especially if standards close to the electrode limit of detection are used in the calibration.

Blank correction occurs automatically when three or more standards are used. This feature automatically calculates and corrects for background levels of the species of interest. The standards used for calibration do not need to include a blank. This improves results as typical blanks contain low levels of the species to be measured and hence, are unstable and difficult to measure accurately. To take advantage of this feature, select three or more standards for calibration. If the profile of the calibration curve does not indicate a background level of ion concentration, then blank correction will not be invoked and the standard point to point scheme will be used.

During calibration, to enter a new concentration value, you must use the scroll▲ or ▼ keys. Each digit is edited in turn (similar to a multifunction watch with LCD display). First set the decimal point, then edit each digit of the display. Keep in mind that there are 4.5 digits and a polarity sign.

Any convenient units of concentration units can be used, for example: molarity, ppm, % etc.

All standards and samples should be at the same temperature. In concentration mode, the temperature probe is used for temperature measurements only and does not provide temperature-corrected concentration measurements.

Prior to calibration, set the number of significant digits required in the setup menu. Check the other parameters and verify each is set appropriately for your measurement procedures.

Two or More Standard Calibration

1. See the electrode instruction manual for electrode preparation, required solutions and any special requirements.
2. Prepare the standards. The standards should bracket the expected sample range and be in the same concentration units.
3. Add ionic strength adjustor, or pH adjustor, as recommended in the electrode instruction manual.
4. Connect the electrode(s) to the meter. Press the **mode** key until the CONC mode indicator is displayed.
5. Rinse the electrode(s) and place into the least concentrated standard.
6. Press the **2nd** then the **cal** keys. CALIBRATE and the time and date of the last calibration will be displayed. After a few seconds, P1 will be displayed indicating the meter is ready for the first standard.
7. When READY is displayed, indicating electrode stability, use the scroll (**▲** or **▼**) keys to enter the value of the standard. The value will flash. Press the **▲** key again and the decimal point will flash. Position the decimal, then press the **yes** key. The first digit will flash. Scroll to the desired value using the **▲** or **▼** keys, then press the **yes** key. Continue for each digit on the display, then press the **yes** key to enter the value into the meter memory. There are 4 1/2 digits plus a polarity sign and decimal point. The display will freeze for three seconds. Then P2 will be displayed in the lower field.
8. Rinse the electrode(s) and place into second standard. When the reading is stable, enter the value of the standard as above. The reading will freeze for three seconds. Then P3 will be displayed in the lower field, indicating the meter is ready for the third standard.
9. If using only two standards, press the **measure** key. The electrode slope will be displayed for a few seconds. Then the meter will advance to MEASURE mode. If using more than two standards, continue to enter standards as described above. When all standards have been entered, press the **measure** key. The meter displays the electrode slope for three seconds, then advances to measure mode. After five standards have been entered, the meter will automatically display the slope then advance to measure mode.
10. Rinse the electrode(s) and place into sample. When READY is displayed, indicating electrode stability, record the concentration directly from the main meter display. Temperature is displayed in the lower field.

Calibration with One Standard

1. See the electrode instruction manual for electrode preparation, required solutions and any special requirements.
2. Prepare a standard which best approximates the expected sample concentration.
3. Add ionic strength adjustor, or pH adjustor, as recommended in the electrode instruction manual.
4. Connect the electrode(s) to the meter and press the **mode** key until the CONC mode indicator is displayed.
5. Rinse the electrode(s) and place into the standard.
6. Press the **2nd** then the **cal** keys. CALIBRATE and the time and date of the last calibration will be displayed. After a few seconds, P1 will be displayed in the lower field indicating the meter is ready for the standard.
7. When READY is displayed, indicating electrode stability, use the scroll (**▲** or **▼**) keys to enter the value of the standard. The value will flash. Press the **▲** key again and the decimal point will flash. Position the decimal, then press the **yes** key. The first digit will flash. Scroll to the desired value using the **▲** or **▼** keys, then press the **yes** key to enter into the meter memory. Continue for each digit on the display, then press the **yes** key to enter the value into memory. There are 4 1/2 digits plus a polarity sign and decimal point. The display will freeze for three seconds. Then P2 will be displayed in the lower field.
8. Press the **measure** key. The electrode slope in memory will now be displayed in the main field and SLP will be displayed in the lower field. If correct, press the **yes** key to enter the value into memory. The meter will automatically advance to measure mode. Otherwise, enter the correct electrode slope using the **▲** or **▼** keys, then press the **yes** key.
9. Rinse the electrode(s) and place into sample. When READY is displayed, indicating electrode stability, record the concentration directly from the main meter display. Temperature is displayed in the lower field.

Millivolt Measurements

The Orion 290Aplus Meter can be used to measure absolute or relative millivolts. The millivolt modes are useful for potentiometric titrations and preparing calibration curves. Detailed instructions for any Orion electrode are given in the electrode instruction manual. Titration instructions are included in the Orion Redox Electrode (Orion 96-78 or 97-78) Instruction Manual, or in standard analytical chemistry texts.

Absolute Millivolts

Absolute millivolts are displayed with 0.1mV resolution in the range of -1600.0 to +1600.0.



Access the absolute millivolt mode by pressing the **mode** key until the mV mode indicator is displayed.

Relative Millivolts

Relative millivolts are displayed to 0.1mV resolution over the range of -1999.9 to +1999.9 (Absolute millivolt range of ± 1600.0 mV).

Access the relative millivolt mode by pressing the **mode** key until the Rel mV mode indicator is displayed.

Setting Relative Millivolt Offset

1. Press the **2nd** then the **cal** keys. CALIBRATE will be displayed and the current absolute millivolts will be displayed in the main field.
2. When the reading is stable, 0.0 will flash. If this is correct, press the **yes** key. If not, use the scroll ( or ) keys to set the desired mV value for the solution. Press the **yes** key to enter. The meter automatically returns to measure mode and all relative millivolt measurements will be based on the offset.

F. Dissolved Oxygen Measurements

Dissolved oxygen measurements are displayed in ppm when the Orion 97-08 Dissolved Oxygen Electrode is used with the Orion 290Aplus Meter. Follow these instructions for preparing the meter and calibrating the electrode.

1. Connect the Orion 97-08 to meter and leave electrode mode switch "OFF".
2. Disconnect the ATC probe.
NOTE: ATC probe must not be connected to the meter.
3. Press the **mode** key until the pH mode indicator is displayed.
4. Turn the hold feature (1-2) off.
5. Press the **measure** key. Using the scroll (**▲** or **▼**) keys, change the temperature value to 25.0 °C.
6. Press the **2nd** then the **cal** keys. Enter the value 7.00 then press the **yes** key.
7. Press the **measure** key. The slope prompt, SLP, will be displayed in the lower field. Enter 100.0 then press the **yes** key. The meter automatically enters the measure mode.
8. Turn the mode switch on the electrode to BT CK. Good battery operation is indicated by a reading of 13.40 or greater on the meter.
9. Turn the mode switch on the electrode to ZERO. Use the zero calibration control to set the meter to read 0.00.
10. Insert the reservoir (funnel) into a BOD bottle containing enough water to just cover the bottom. Insert the electrode, making sure that the electrode tip is not immersed in the water and does not have water droplets clinging to the outside of the membrane. Let stand approximately 30 minutes to ensure water saturation of air in the BOD bottle. This bottle should be used for storage between measurements.
11. Turn the electrode mode switch to the AIR position. If measurements are being made at sea level, use the AIR calibration control on the electrode to set the pH meter reading to the prevailing barometric pressure in mm Hg (divided by 100). If the barometric pressure is unknown, if the elevation is above sea level or if the sample has a salinity greater than 2 parts per thousand, consult Table 1 found in the Orion 97-08 Instruction Manual to obtain the correct AIR setting.
12. Turn the electrode mode switch to H₂O for sample analysis.

Chapter VIII

Temperature Compensation

pH measurements on the Orion portable meters may be made with either Automatic Temperature Compensation (ATC) or Manual Temperature Compensation.

For Automatic Temperature Compensation, a temperature probe must be used. Live temperature readings will be displayed in the lower field along with the °C and ATC legends. Temperature-corrected pH values will be displayed in the main field.

Disconnect the temperature probe when performing Manual Temperature Compensation. While in MEASURE mode, temperature values can be entered manually using the **scroll** keys. The value will be displayed in the lower field. Temperature-corrected pH values, based on the manually entered temperature, will be displayed in the main field.

To calibrate using manual temperature compensation, all buffers must be at the same temperature. While in measure mode, scroll in the temperature value of the buffer(s). Then start the calibration sequence. Follow calibration instructions for your meter. After calibration, varying sample temperatures may be entered while in measure mode by using the scroll (▲ or ▼) keys.

The maximum temperature display for either automatic or manual temperature compensation is 105 °C. The minimum temperature is -5.0 °C.

For the Orion 230Aplus, Orion 250Aplus and Orion 290Aplus, there is no temperature compensation for any mode other than pH and E_H , if present, when using Orion standard and electrodes. The temperature display in mV, relative mV and concentration modes reflect the sample temperature only.

Chapter IX

Use with Accessories

A. Use with Printer and Computers

The 250Aplus can send information to a printer or other serial peripheral using the RS232-C output. The 290Aplus can be used with either computers or printers and can be controlled remotely from an RS232 communication device. The RS232-C output on the 290Aplus is bi-directional.

The following information can be used to interface the meter to your printer or computer.

Baud rate: 1200.

Eight data bits, no parity.

One start bit, one stop bit.

Meter	Pin	Printer
RXD	2	
TXD	3	RXD
DSR	4	
SIG GND	5	SIN GND
DTR	6	
RTS	7	
CTS	8	RTS

Jumper 4 and 6 together.

The RS232C port on the meter is a nine pin D-shell subminiature male connector (DB-9 style).

Use Orion Cable, No. 0ACBL0

B. Remote Control

The Orion 290Aplus can be remotely controlled from an RS232 communication device or PC. After making the physical connection between your meter and computing device, type rem then enter into your computer to establish communication.

The following are the remote control commands

Command	Function or meaning
rem	remote log in
help	displays help menu
+	increase value, scroll up
-	decrease value, scroll down
cal	calibrate
disp	display LCD image
meas	measure
mode	change modes
n	no
off	shut down, turn off setup
setup	go to setup menu
timer	timer, start timer
y	yes
mp	prints value, mode, and temperature
pr	print/datalog
exit	exit remote control

NOTE: *help and rem are not displayed in the help menu.*

This is an example of a program written in basic which monitors the meter for pH data every five seconds and prints the data if the pH value is less than nine.

- ‘ This BASIC program monitors the meter to read pH value every
- ‘ five seconds and prints the data if pH is less than 9.
- ‘ To stop the program, press “E” or “e” key.

‘*****

```

REM HANDLE ALL SYSTEM ERRORS
ON ERROR GOTO ERRHANDLE
CLS
CLOSE #2:
REM SET THE PARAMETERS FOR THE RS232 PORT
OPEN "COM1:1200,N,8,1" FOR RANDOM AS #2

REM MAKE SURE WE ARE NOT CURRENTLY LOGGED ON
GOSUB EXITRC

PRINT #2, "rem": REM SEND THE LOG ON COMMAND
INPUT #2, S$: REM FILTER OUT INCOMING INFORMATION
INPUT #2, S$:
INPUT #2, S$:

WHILE 1
    LOGT = TIMER + 5: REM SETUP LOG TIMER
    WHILE (TIMER < LOGT)
        KP$ = "": REM CHECK FOR USER REQUEST TO EXIT
        KP$ = INKEY$
        IF KP$ = "E" OR KP$ = "e" THEN GOTO ENDPROG
    WEND
    GOSUB CHECKPH: REM CHECK CURRENT READING
    IF (PH < 9) THEN GOSUB LOGDATA: PRINT "1 DATA POINT LOGGED"

WEND

ERRHANDLE:
    PRINT "SYSTEM ERROR ENCOUNTERED..."
    PRINT ERR: REM INDICATE SYSTEM ERROR CODE
    
```

ENDPROG:

```
GOSUB EXITRC
LPRINT "END OF PROGRAM"
CLOSE #2:
END
```

CHECKPH:

```
PRINT #2, "mp": REM SEND THE mp COMMAND TO READ
: REM THE CURRENT PH VALUE
INPUT #2, S$: REM FILTER OUT INCOMING INFORMATION
INPUT #2, S1$: REM CAPTURE CURRENT PH READING
INPUT #2, S$: REM FILTER OUT INCOMING INFORMATION
INPUT #2, S$
PH = VAL(S1$): REM CONVERT THE RECEIVED PH STRING TO VALUE
RETURN
```

LOGDATA:

```
S$ = "": REM CLEAR STRING BUFFER
PRINT #2, "pr": REM SEND THE pr COMMAND TO PRINT
: REM PH, MV, TEMP AND DATE

INPUT #2, S$
FOR I = 1 TO 7
    INPUT #2, S$
    LPRINT S$: REM DIVERT OUTPUT TO PRINTER
NEXT I
RETURN
```

EXITRC:

```
PRINT #2, "exit": REM LOG OFF
INPUT #2, S$
INPUT #2, S$
RETURN
```

Chapter X

Troubleshooting

A. Self-Test

During the self-test, the meter will display various codes corresponding to the section of the instrument being checked. If any problems are found, an operator assistance code, corresponding to the test that failed, will be displayed. Note the code and press any key to continue. See Table 1 under operator assistance codes. Should an operator assistance code appear during self-test, check to make sure that the shorting cap is securely attached. Then repeat the test. If the problem persists, contact Orion's Product Service Department at 1-800-225-1480.

During the self-test, the meter displays 7E57 in the main field and the number of the test in the lower field. Additional meter displays occur depending on the test being performed.

NOTE: Ensure shorting cap is on prior to self-test.

Test	Function/ Display	Sequence
Test #1	Segment Display	Checks meter display. Ensure all segments are lit.
Test #2	RAM Check	Verifies the external RAM is functioning properly.
Test #3	External Input	Checks the electrode input channel. The shorting plug must be on for this test to pass properly.
Test #4	Internal Check	Internal function test.
Test #5	Internal Reference	Checks the internal reference on the meter.
Test #6	Ground Reference	Checks the meter ground.

Test	Function/ Display	Sequence
Test #7	Keypad Test	<p>Checks that the keypad is functioning properly. During this test, all keys must be pressed at the 0 prompt. Press each key. As each key is pressed, a number, corresponding to each key, is displayed. When all keys have been pressed, the ready icon is turned on.</p> <p>If no keys are pressed or there is a problem with a key, the meter will recognize an error and display E-7. Press yes to continue.</p>
Test #8	Autoshutoff Test	<p>Checks the meter autoshutoff feature. The display clears. Then the meter shuts off. The Orion 210Aplus and 230Aplus remain off.</p> <p>After 5 seconds, the Orion 250Aplus and 290Aplus turn on again and resume normal operation.</p>

NOTE: *If any operator assistance codes appear, make a note of each. Then press **yes** to continue.*

B. Operator Assistance Code

Operator Assistance Codes are used to inform the user of an out of range value or meter problem. The following tables outline the operator assistance codes available in the portable meter series.

The meter has a self-test circuit that verifies proper electronic operation. During self-test, a special series of codes, E-00 through E-08, indicate a problem with the meter hardware. See Table I. If one of these codes appears, contact Orion's Technical Service Department at 1-800-225-1480.

**Table I Operator Assistance Codes
Self Test**

Error Code

E-2	Ram Check Error
E-3	Input Channel Error: Check to make sure the shorting cap is securely in place on the input connector and repeat self-test.
E-4	Internal Check
E-5	Internal Reference Error
E-6	Ground Test Error
E-7	Internal Keypad Error: Press each key while in self-test. If E-7 occurs, repeat the self-test ensuring that all keys are pressed within 10 seconds. If code persists, contact Orion Technical Service Group.
E-8	Instrument Shutdown Error

The Operator Assistance Codes E-20 through E-32 alert the user to a potential problem while calibrating or measuring. Several steps can be taken to eliminate the problem in each case. If the code persists after trying the suggested remedies, contact Orion Technical Service Group.

Table II Operator Assistance Codes

Error Code	Problem	Probable Remedy
E-20	out of range pH, mV, Rel mV, or conc out of range	<ol style="list-style-type: none"> 1. If this occurs when electrodes are out of solution, code will disappear when electrodes are returned to solution. 2. Verify electrodes are properly connected. 3. Sample may be out of range. Check a buffer or standard. 4. Check slope value. On the 250Aplus or 290Aplus, check the isopotential point setting. 5. Recalibrate using fresh buffers or standards. 6. Check that ATC probe is connected properly and make sure temperature is within -5.0 to 105 °C.
E-21	ABR error pH autocalibration error ORP mV out of range	<p>Electrode voltage being measured is > ±0.5 pH units from the nominal value for the pH buffer, or ±60mV from the nominal 220 mV value in E_H ORP mode</p> <ol style="list-style-type: none"> 1. Verify buffer is either 1.68*, 4.01, 7.00, 10.01 or 12.45*. (* 290Aplus only) 2. Press any key and recalibrate that point using fresh buffer. 3. Clean electrodes and refill reference electrode. Recalibrate.

Error Code	Problem	Probable Remedy
E-22	Calibration Standard Error	<p>4. Perform a manual calibration. Some electrodes may operate outside of the range for pH autocalibration. This is normal and may become more evident as an electrode ages.</p> <p>The millivolts being measured are the same for two different standards or buffers.</p> <ol style="list-style-type: none"> 1. Press any key to acknowledge. 2. Check that two different standards or buffers are being used and that the correct one is being measured. 3. Use fresh standards or buffers and repeat the last calibration point or the entire calibration.
E-23	Bad Slope	<p>pH electrode slope not in the range of 80% to 120%</p> <ol style="list-style-type: none"> 1. Press any key to acknowledge and repeat calibration using fresh buffers. 2. Clean electrodes and refill reference electrode. 3. Refer to electrode instruction manual for instructions on how to check electrode operation.
E-26	Datalog Full	<p>The datalogger is full and cannot store any more points. A maximum of 25 points may be stored.</p> <ol style="list-style-type: none"> 1. Transfer data to a printer or computer. 2. Clear the data from memory. Go to 6-4 in the setup menu and press the yes key. <p>Once the data has been cleared, additional points may be logged.</p>

Error Code	Problem	Probable Remedy
E-27	Data Transfer Error	<p>There is a problem in transferring data from the datalogger on the 290Aplus to a printer or computer.</p> <ol style="list-style-type: none">1. Check to make sure the printer or other device is securely plugged into the RS232-C port on the right-hand side of the meter.2. Check to make sure your printer or computer is on and ready to receive information from the meter.3. Check your cable to make sure it matches the pin configuration. Use Orion No. 0ACBL0 for IBM PC or compatible devices.
E-29	Printer Error (Orion 250Aplus and 290Aplus only)	<p>The meter is sending information to a printer and there is no printer plugged into the meter or the printer is not turned on.</p> <ol style="list-style-type: none">1. Plug in the printer and turn it on.2. If no printer is available, select manual print in the setup menu.

Error Code	Problem	Probable Remedy
E-31	Bad Value	<p>A value has been entered which is not within the acceptable range for that function.</p> <ol style="list-style-type: none"> 1. Press any key to acknowledge the error. 2. Re-enter a new value within the allowable range. Acceptable values are as follows: pH: -2.000 to +19.999 pH slope: 80% to 120% timer interval: 5 seconds to 23 hours, 59 minutes and 59 seconds relative millivolts: -1999.9 to +1999.9 (230Aplus, 250Aplus and 290Aplus) Concentration: 0.000 to 19900 (290Aplus)
E-32	Blank Error The meter is unable to calculate a blank value. (Orion 290Aplus only)	<p>This error occurs during a 3 or more point calibration when one solution has been defined as zero concentration and the actual concentration of the blank is substantially greater than the standard with the third highest concentration. This can also occur during a one or two point calibration if one of the standards is defined as zero.</p> <ol style="list-style-type: none"> 1. Check to make sure electrodes were placed into the proper standards and blank solution and recalibrate. 2. Repeat calibration using fresh blank and standards. 3. If performing a two-point calibration, recalibrate using two standards of known concentration other than zero.

C. Troubleshooting Guide

Malfunction	Possible Cause	Remedy
No Display	No power to meter	<p>Press the power key.</p> <p>Check to ensure battery is inserted correctly and polarity signs match. Replace battery if operating on battery power.</p> <p>Check that the line converter is plugged in securely.</p>
	Autoshutoff may be turned on.	<p>When the Autoshutoff feature is on, the meter will automatically shut down if no keys have been pressed within 10 minutes. Press the power key to turn the meter on. If this feature is not desired, disable autoshutoff. Go to 1-4 in the setup menu and change the setting.</p>
Erratic Readings or Reading Out of Range	Meter or electrode failure	<p>Follow the meter check out procedure that pertains to your meter.</p> <p>Check electrode operation by following the instructions in the electrode instruction manual.</p>
Trouble Calibrating in Autocalibration	Some electrodes may operate outside the limits of ± 0.5 pH units	<p>Perform a manual calibration.</p> <p>Check temperature and slope. Then repeat calibration.</p> <p>Buffers used may be out of specification.</p> <p>Repeat calibration, using fresh buffers.</p>

Chapter XI

Warranty

For the most current warranty information, visit www.thermo.com.

The Thermo Electron Corporation, Orion products warranty covers failures due to manufacturer's workmanship or material defects from the date of purchase by the user. User should return the warranty card and retain proof of purchase. Warranty is void if product has been abused, misused, or repairs attempted by unauthorized persons.

Warranties herein are for product sold/installed by Thermo or its authorized dealers.

Any product sold by a U.S. or Canadian distributor must be returned to Thermo for any warranty work. Please contact our Technical Service department for further information. A Return Authorization Number must be obtained from The Technical EDGESM For Orion Products before returning any product for in-warranty repair or replacement.

In the event of failure within the warranty period, Thermo will at the company's option, repair or replace product not conforming to this warranty. There may be additional charges, including freight, for warranty service performed in some countries. For service, call Thermo or its authorized dealer outside the United States and Canada. Thermo reserves the right to ask for proof of purchase, such as the original invoice or packing slip.

Field Service is available on Orion BOD AutoEZTM, EZ Flash[®] GC Accessory and TEA Analyzer[®]. Contact our Field Service department for details on quotations, service, other field service-related activities.

The following products are warranted to be free from defects in material and workmanship in the period listed below from the date of purchase from the user or from the date of shipment from Thermo, whichever is earlier, provided use is in accordance with the operating limitations and maintenance procedures in the instruction manual and when not having been subjected to accident, alteration, misuse, abuse or breakage of electrodes:

Thirty-six months from date of purchase by the user (or forty-two months from date of shipment from Thermo)

- Waterproof Meters (Orion 630, 635, 830A, 835A, 260A, 261S, 265A, 266S, 130A, 131S, 135A, 136S, 1230, 142 and 842), Conductivity Meters (Orion 105AplusTM, 115AplusTM, 125AplusTM, 145AplusTM, 150AplusTM and 162A), PerpHect[®] pH/ISE Meters (Orion 310, 320, 330, 350, 370) pH/ISE Meters (Orion 210AplusTM, 230AplusTM, 250AplusTM, 290AplusTM, 410AplusTM, 420AplusTM, 520AplusTM, 525AplusTM, 710AplusTM, 720AplusTM and 920AplusTM), pHuture MMSTM Meters (Orion 535A and 555A),

pH/Conductivity Meter (Orion 550A), Dissolved Oxygen Meters (Orion 805Aplus™, 810Aplus™, 850Aplus™ and 862A).

Twenty-four months from date of purchase by the user (or thirty-six months from date of shipment from Thermo)

- Orion ROSS Ultra™ Electrodes, AQUAfast® IV Colorimeters, AQUAfast® IV Turbidimeter, Orion 925 Flash Titrator™, Series 100 DuraProbe™ Conductivity Cells and Series 800 Dissolved Oxygen Probes.

Twelve months from date of purchase by the user (or eighteen months from date of shipment from Thermo)

- Laboratory pH Meters, (Orion 301, 611 and 940), SensorLink®, pHuture™ pH Meters (Orion 610 and 620), Smart Chek™ meters, Sage® Pumps, Cahn® Balances, 930 Ionalyzer®, 950 ROSS™ FAST QC™ Titrator, 960 Titrator PLUS®, Karl Fischer Titrators, Autosamplers, Liquid Handling Devices, Liquid Handling Automation Workstations (Orion AS2000, AS2500 and AS4000), Pumps (Orion SP201, SP201-HR, SP201-S, Peristaltic and Rinse), pHuture® Conversion Box, Wine Master®, 607 Switchbox, rf link™, AQUAfast® II Colorimeters, Vacuum Degasser and Flowmeter.
- Orion EZ Flash® GC Accessory, Orion TEA Analyzer® 610 and 510 excluding consumable items carry twelve months warranty only.
- Orion Ion Selective Electrodes, ionplus® Electrodes, ROSS™ Electrodes, Sure-Flow® Electrodes, PerpHecT® Electrodes, AquaPro Professional Electrodes, No Cal™ pH electrodes, Standard Line pH Electrodes, Tris pH Electrodes, KNIPHE® electrode, ORP Triode™ (Orion 9180BN), pHuture™ pH Probes (Orion 616500) and pHuture MMS™ Quatrode™ and Triode™ (Orion 616600 and 617900), Orion 97-08 DO Probe, Series 100 Conventional Conductivity Cells, temperature probes and compensators (except those products noted).
- Orion 93 and 97 ionplus Series sensing modules are warranted to give six months of operation if placed in service before the date indicated on the package, except 93-07 and 97-07 Nitrate modules are warranted to give ninety days of operation if placed in service before the date indicated on the package.

Six months from date of purchase by the user (or twelve months from date of shipment from Thermo)

- Orion Flash Titration™ Probe (Orion 092518), pHuture™ Electrode (Orion 615700), pHuture MMS™ Pentrode™ (Orion 617500), Quatrode™ (Orion 617800) and Triode™ (Orion 615800), Low Maintenance Triode™ (Orion

9107BN), ORP Low Maintenance Triode™ (Orion 9179BN), and PerpHecT® Low Maintenance Triode™ (Orion 9207BN), Waterproof Triode™ (Orion 9107WP, 9107WL, 9109WL and 9109WP), QuiKcheK® Meters and Micro Electrodes.

Three months from date of purchase by the user (or six months from date of shipment from Thermo)

- Economy Line Electrodes, Orion 91-05, 91-06, 91-15, 91-16, 91-25, 91-26, 91-35, 91-36, 92-06. Warranty also includes failure for any reason (excluding breakage), except abuse, provided the electrode is not used in solutions containing silver, sulfide, perchlorate, or hydrofluoric acid; or in solutions more than one (1) Molar in strong acid or base at temperatures above 50 °C.

“Out-of-Box” Warranty - Should any of the following products fail to work when first used, contact Thermo immediately for replacement.

- Orion Solutions, Standards, Reagents, Cables, Ferrules, Tubing, Line adapters, Printers, Software, Cases, Stands, Probe Membranes, AQUAfast® Test Strips, EZ Flash® columns, Liquid Handling Probes, Adapter Plates and Racks and general accessories.

For products in the catalog not listed in this warranty statement, please visit our website at: www.thermo.com

THE WARRANTIES DESCRIBED ABOVE ARE EXCLUSIVE AND IN LIEU OF ALL OTHER WARRANTIES WHETHER STATUTORY, EXPRESS OR IMPLIED INCLUDING, BUT NOT LIMITED TO, ANY IMPLIED WARRANTY OF MERCHANTABILITY OR FITNESS FOR A PARTICULAR PURPOSE AND ALL WARRANTIES ARISING FROM THE COURSE OF DEALING OR USAGE OF TRADE. THE BUYER'S SOLE AND EXCLUSIVE REMEDY IS FOR REPAIR OR REPLACEMENT OF THE NON-CONFORMING PRODUCT OR PART THEREOF, OR REFUND OF THE PURCHASE PRICE, BUT IN NO EVENT SHALL THERMO (ITS CONTRACTORS AND SUPPLIERS OF ANY TIER) BE LIABLE TO THE BUYER OR ANY PERSON FOR ANY SPECIAL, INDIRECT, INCIDENTAL, OR CONSEQUENTIAL DAMAGES WHETHER THE CLAIMS ARE BASED IN CONTRACT, IN TORT (INCLUDING NEGLIGENCE), OR OTHERWISE WITH RESPECT TO OR ARISING OUT OF THE PRODUCT FURNISHED HEREUNDER.

REPRESENTATION AND WARRANTIES MADE BY ANY PERSON, INCLUDING ITS AUTHORIZED DEALERS, REPRESENTATIVES AND EMPLOYEES OF THERMO WHICH ALTER OR ARE IN

ADDITION TO THE TERMS OF THIS WARRANTY SHALL NOT BE BINDING UPON THERMO UNLESS IN WRITING AND SIGNED BY ONE OF ITS OFFICERS.

Chapter XII

Repair and Service

After troubleshooting all components of your measurement system, contact The Technical EdgeSM for Orion products. Within the United States call 1.800.225.1480, outside the United States call 978.232.6000 or fax 978.232.6031. In Europe, the Middle East and Africa, contact your local authorized dealer. For the most current contact information, visit www.thermo.com.

Chapter XIII

Notice of Compliance

Warning: This meter may radiate radio frequency energy and if not installed and used properly, that is in strict accordance with the manufacturer's instructions, may cause interference to radio communications. It has been tested and found to comply with the limits for a Class A computing device pursuant to Subpart J of Part 15 of FCC Rules, which are designed to provide reasonable protection against such interference in a commercial environment. Operation of the meter in a residential area may cause interference in which case the user at his own expense will be required to take whatever measures may be required to correct the interference.

***NOTE:** To meet or exceed FCC Compliance Orion supplied wall adapters must be used with these products.*

This digital apparatus does not exceed the Class A limits for radio noise emissions from digital apparatus set out in the Radio Interference Regulations of the Canadian Department of Communications.

Le present appareil numerique n'emmet pas de bruits radioelectriques depassant les limites applicables aux appareils numeriques de la class A prescrites dans le Reglement sur le brouillage radioelectrique edicte par le ministere des Communications du Canada.

Declaration of Conformity

Thermo Electron Corporation

Manufacturer:

Thermo Electron Corporation
166 Cummings Center
Beverly, MA 01915 U.S.A.

hereby declares that the products

Portable pH Orion 290Aplus
 250Aplus
 230Aplus
 210Aplus

conforms with the following standards and documents

- Safety: EC Directive 72/23/EEC Low Voltage Directive
 DIN VDE 0700 Transformers
 UL 1310 Class 2 Power Units
 CSA C22.2 No. 223 Extra-Low Voltage Transformers.
- EMC: EC 89/336/EEC Electromagnetic Compatibility
- Emissions: EN 55022 Emissions Class A
 FCC Part 15 Class A
- Immunity: EN 50082-1 Generic Immunity
 IEC 801-2 ESD Susceptibility
 IEC 801-3 Radiated Susceptibility
 IEC 801-4 Conducted Susceptibility

These Orion products have been manufactured in compliance with the provisions of the relevant Thermo Electron manufacturing and test documents and processes. Further, these documents and processes are recognized as complying with ISO 9000:2000 by QMI, listed as File # 001911.

Place and date of issue:
Beverly, MA.
June, 2003

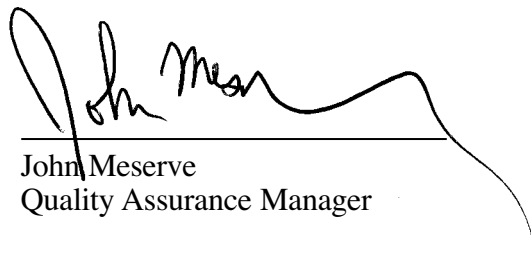

John Meserve
Quality Assurance Manager

Chapter XIV

Ordering Information

Orion No.	Description
0210A0	Orion 210Aplus Portable pH/Temperature Meter. Includes Orion Triode combination pH and ATC electrode.
0230A0	Orion 230Aplus Portable pH/Temperature Meter. Includes Orion Triode combination pH and ATC electrode.
0250A0	Orion 250Aplus Portable pH/Temperature/mV Meter. Includes Orion Triode combination pH and ATC electrode.
0290A0	Orion 290Aplus Portable pH/ISE/Temperature/mV Meter. Includes Orion Triode combination pH and ATC electrode.
0PBLSK	Starter Kit for Portable Meters. Includes Rugged Carrying Case, Electrode Holder and Stand, one 2 oz. bottle of Electrode Storage Solution, two each of pH 4 Buffer Solution, 2 oz., pH 7 Buffer Solution, 2 oz., and pH 10 Buffer Solution, 2 oz., one 150 mL plastic beaker, and two electrode clips.
0900A0	Portable Printer for Orion Meters. Includes rechargeable battery and one roll of printer paper.
0900A1	Portable Printer for Orion Meter. Same as above except 220 V.
0ACBL0	RS232 Interface Cable for use with computers IBM PC or compatible devices.
9165BN	Ag/AgCl epoxy Sure-Flow pH Electrode
9157BN	Orion Triode 3 in 1 Combination pH/ATC Probe for Orion A Series Meters
917005	ATC Probe for Orion A Series Meters
910600	Gel-filled, combination pH Electrode
9107BN	Gel Triode
8102BN	Ross Combination Glass pH Electrode
8172BN	Ross Sure-Flow Combination Glass pH Electrode
8165BN	Ross Sure-Flow Epoxy-Body Combination pH Electrode

Orion No.	Description
8175BN	Ross Sure-Flow® Semi-Micro Epoxy-Body Combination pH Electrode
090070	Electrode Holder and Stand
020125	Line Converter, 110V
020130	Line Converter, 220V
910104	pH 4 Buffer Solution, 475 ml
910107	pH 7 Buffer Solution, 475 ml
910110	pH 10 Buffer Solution, 475 ml
910410	PerpHect™ Buffer 4, color coded, 10 pack
910425	PerpHect Buffer 4, color coded, 25 pack
910710	PerpHect Buffer 7, color coded, 10 pack
910725	PerpHect Buffer 7, color coded, 25 pack
911010	PerpHect Buffer 10, color coded, 10 pack
911025	PerpHect Buffer 10, color coded, 25 pack
910001	pH Electrode Storage Solution, 475 mL
967901	ORP Standard, 475 mL
967961	ORP Standard, 60 mL bottle, 5 pack
212843-001	Electrode Clip
213945-A01	Electrode Storage Compartment

NOTE: A wide selection of Ion Selective Electrodes and other replacement parts are available. Contact Thermo Electron or your local authorized distributor for more information.

Chapter XV

Specifications

	210Aplus	230Aplus	250Aplus	290Aplus
pH range	0.00 to 14.00	-2.00 to 19.99	-2.00 to 19.99	-2.00 to 19.99
resolution	0.01/0.1	0.01/0.1	0.01/0.1	0.001/0.01/0.1
relative accuracy	± 0.02	± 0.02	± 0.02	± 0.005
slope	80% to 120%	80% to 120%	80% to 120%	80% to 120%
Concentration range				0.000 to 19900
resolution				± one least significant digit
relative accuracy				± 0.5% of reading
Millivolt range			-1600.0 to +1600.0	-1600.0 to +1600.0
resolution			0.1mV	0.1mV
relative accuracy			0.2 mV or ±0.05% of ΔE, whichever is greater	0.2 mV or ±0.05% of ΔE, whichever is greater
Relative millivolt range		-1999.9 to +1999.9	-1999.9 to +1999.9	-1999.9 to +1999.9
resolution		0.1 mV	0.1 mV	0.1 mV
relative accuracy		0.2 mV or +0.05% of ΔE, whichever is greater	0.2 mV or +0.05% of ΔE, whichever is greater	0.2 mV or +0.05% of ΔE, whichever is greater
ORP to NHE		yes	yes	
Temperature range	-5.0 to 105 °C	-5.0 to 105 °C	-5.0 to 105 °C	-5.0 to 105 °C
resolution	0.1 °C	0.1 °C	0.1 °C	0.1 °C
relative accuracy	± 1.0 °C	± 1.0 °C	± 1.0 °C	± 1.0 °C
Display	Custom LCD	Custom LCD	Custom LCD	Custom LCD
Inputs	BNC, pin tip, ATC(DIN), power	BNC, pin tip, ATC(DIN), power	BNC, pin tip, ATC(DIN), power	BNC, pin tip, ATC(DIN), power
Outputs			RS232	RS232
Power requirements	One 9V alkaline battery, or one 9V lithium battery, or line adapter for either 110 or 220 VAC, 50/60 Hz wall outlet			
Input impedance	> 10 ¹² ohms			
Instrument drift	< 50 microvolts/°C			
Input bias current	< ± 1 picoamp at 25 °C and < ± 4 picoamps over full operating range			
Environmental requirements	5 to 45 °C and 5 to 85% relative humidity, non-condensing			
Meter dimensions	8.08 x 3.26 x 1.90 inches			
Case	Dust and Splash Resistant, Chemical Resistant			

Environmental Instruments

Water Analysis

North America

166 Cummings Center
Beverly, MA 01915 USA
Tel: 978-232-6000
Dom. Fax: 978-232-6015
Int'l. Fax: 978-232-6031

Europe

12-16 Sedgeway Business Park
Witchford, Cambridgeshire
England, CB6 2HY
Tel: 44-1353-666111
Fax: 44-1353-666001

Far East

Room 904, Federal Building
369 Lockhart Road
Wanchai, Hong Kong
Tel: 852-2836-0981
Fax: 852-2834-5160

Customer Support

Toll Free: 800-225-1480
www.thermo.com
Dom. e-mail: domcs1@thermoorion.com
Int'l. e-mail: intcs1@thermoorion.com

For updated contact information, visit www.thermo.com

Analyze • Detect • Measure • Control™

233574-001 Rev.C

Thermo
ELECTRON CORPORATION