

OPTICAL PARTICLE SIZER SPECTROMETER MODEL 3330

OPERATION AND SERVICE MANUAL

P/N 6004403, REVISION F
OCTOBER 2013

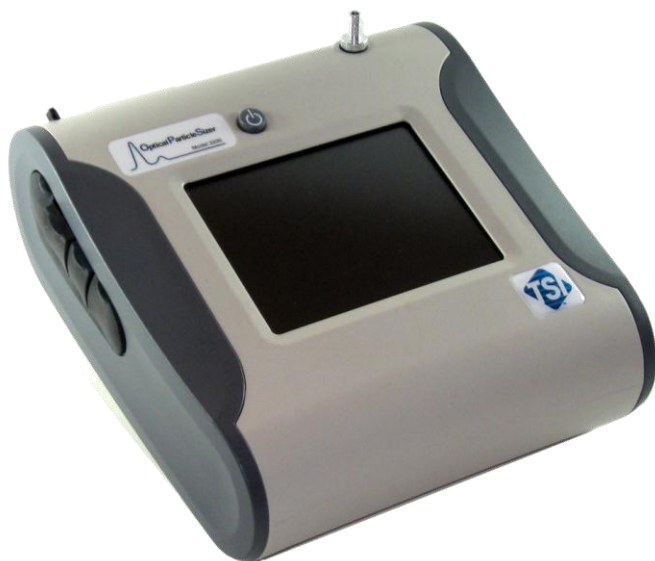

START SEEING THE BENEFITS OF REGISTERING TODAY!

Thank you for your TSI instrument purchase. Occasionally, TSI releases information on software updates, product enhancements and new products. By registering your instrument, TSI will be able to send this important information to you.

<http://register.tsi.com>

As part of the registration process, you will be asked for your comments on TSI products and services. TSI's customer feedback program gives customers like you a way to tell us how we are doing.



UNDERSTANDING, ACCELERATED

TSI Incorporated - Visit our website **www.tsi.com** for more information.

USA	Tel: +1 800 874 2811	India	Tel: +91 80 67877200
UK	Tel: +44 149 4 459200	China	Tel: +86 10 8219 7688
France	Tel: +33 4 91 11 87 64	Singapore	Tel: +65 6595 6388
Germany	Tel: +49 241 523030		

©2013 TSI Incorporated

Printed in U.S.A.

Manual History

The following is a manual history of the Model 3330 Optical Particle Sizer Spectrometer (Part Number 6004403).

Revision	Date
A	December 2010
B	January 2011
C	January 31, 2011
D	March 2011
E	April 2011
F	October 2013

Warranty

Part Number
Copyright
Address
Email Address
World Wide Web Site
Fax No.
**Limitation of Warranty
and Liability**
(effective June 2011)

6004403 / Revision F / October 2013

©TSI Incorporated / 2010-2013 / All rights reserved.

TSI Incorporated / 500 Cardigan Road / Shoreview, MN 55126 / USA

particle@tsi.com

www.tsi.com

(651) 490-3824

(For country-specific terms and conditions outside of the USA, please visit www.tsi.com.)

Seller warrants the goods sold hereunder, under normal use and service as described in the operator's manual, shall be free from defects in workmanship and material for **12 months**, or if less, the length of time specified in the operator's manual, from the date of shipment to the customer. This warranty period is inclusive of any statutory warranty. **This limited warranty is subject to the following exclusions and exceptions:**

- a. Recalibration, cleaning of contamination, or repair caused by misuse, misapplication, or failure to follow operating instructions or observe cautionary instruction is excluded from coverage.
- b. Internal pump warranty is for 5000 hours of pump run time or (12) months from date of instrument shipment, whichever is shorter.
- c. Hot-wire or hot-film sensors used with research anemometers, and certain other components when indicated in specifications, are warranted for 90 days from the date of shipment.
- d. Parts repaired or replaced as a result of repair services are warranted to be free from defects in workmanship and material, under normal use, for 90 days from the date of shipment;
- e. Seller does not provide any warranty on finished goods manufactured by others or on any fuses, batteries or other consumable materials. Only the original manufacturer's warranty applies;
- f. Unless specifically authorized in a separate writing by Seller, Seller makes no warranty with respect to, and shall have no liability in connection with, goods which are incorporated into other products or equipment, or which are modified by any person other than Seller.

The foregoing is **IN LIEU OF** all other warranties and is subject to the **LIMITATIONS** stated herein. **NO OTHER EXPRESS OR IMPLIED WARRANTY OF FITNESS FOR PARTICULAR PURPOSE OR MERCHANTABILITY IS MADE. WITH RESPECT TO SELLER'S BREACH OF THE IMPLIED WARRANTY AGAINST INFRINGEMENT, SAID WARRANTY IS LIMITED TO CLAIMS OF DIRECT INFRINGEMENT AND EXCLUDES CLAIMS OF CONTRIBUTORY OR INDUCED INFRINGEMENTS. BUYER'S EXCLUSIVE REMEDY SHALL BE THE RETURN OF THE PURCHASE PRICE DISCOUNTED FOR REASONABLE WEAR AND TEAR OR AT SELLER'S OPTION REPLACEMENT OF THE GOODS WITH NON-INFRINGEMENTS.**

TO THE EXTENT PERMITTED BY LAW, THE EXCLUSIVE REMEDY OF THE USER OR BUYER, AND THE LIMIT OF SELLER'S LIABILITY FOR ANY AND ALL LOSSES, INJURIES, OR DAMAGES CONCERNING THE GOODS (INCLUDING CLAIMS BASED ON CONTRACT, NEGLIGENCE, TORT, STRICT LIABILITY OR OTHERWISE) SHALL BE THE RETURN OF GOODS TO SELLER AND THE REFUND OF THE PURCHASE PRICE, OR, AT THE OPTION OF SELLER, THE REPAIR OR REPLACEMENT OF THE GOODS. IN THE CASE OF SOFTWARE, SELLER WILL REPAIR OR REPLACE DEFECTIVE SOFTWARE OR IF UNABLE TO DO SO, WILL REFUND THE PURCHASE PRICE OF THE SOFTWARE. IN NO EVENT SHALL SELLER BE LIABLE FOR LOST PROFITS OR ANY SPECIAL, CONSEQUENTIAL OR INCIDENTAL DAMAGES. SELLER SHALL NOT BE RESPONSIBLE FOR INSTALLATION, DISMANTLING OR REINSTALLATION COSTS OR CHARGES. No Action, regardless of form, may be brought against Seller more than 12 months after a cause of action has accrued. The goods returned under warranty to Seller's factory shall be at Buyer's risk of loss, and will be returned, if at all, at Seller's risk of loss.

Buyer and all users are deemed to have accepted this LIMITATION OF WARRANTY AND LIABILITY, which contains the complete and exclusive limited warranty of Seller. This LIMITATION OF WARRANTY AND LIABILITY may not be amended, modified or its terms waived, except by writing signed by an Officer of Seller.

Service Policy

Knowing that inoperative or defective instruments are as detrimental to TSI as they are to our customers, our service policy is designed to give prompt attention to any problems. If any malfunction is discovered, please contact your nearest sales office or representative, or call TSI at 1-800-874-2811 (USA) or (651) 490-2811.

Trademarks

TSI, TSI logo, and Aerosol Instrument Manager are registered trademarks of TSI Incorporated.

Microsoft, Windows, are registered trademarks of Microsoft Corporation.
Swagelok is a registered trademark of Swagelok® Companies, Solon, Ohio.

Safety

This section gives instructions to promote safe and proper handling of the Model 3330 Optical Particle Sizer Spectrometer.

There are no user serviceable parts inside the instrument. Refer all repair and maintenance to a qualified technician. All maintenance and repair information in this manual is included for use by a qualified technician.

The Model 3330 Optical Particle Sizer spectrometer is a Class I laser-based instrument. During normal operation, you will **not** be exposed to laser radiation. However, you must take certain precautions or you may expose yourself to hazardous radiation in the form of intense, focused, visible light. Exposure to this light may cause blindness.

Take these precautions:

- ❑ Do **not** remove any parts from the OPS spectrometer unless you are specifically told to do so in this manual.
- ❑ Do **not** remove the OPS housing or covers while power is supplied to the instrument.



W A R N I N G

If the OPS 3330 is used in a manner not specified by the manufacturer, the protection provided by the equipment may be impaired.



W A R N I N G

The use of controls, adjustments, or procedures other than those specified in this manual may result in exposure to hazardous optical radiation.







W A R N I N G

The safety certification is only valid when the OPS 3330 is used with TSI 801692 AC adapter and or TSI 801680 battery.

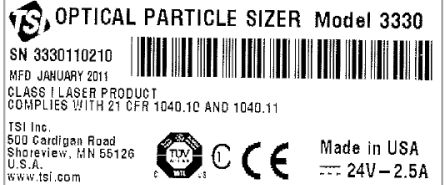
Labels

Advisory labels and identification labels are attached to the outside of the Model 3330 and to the optics housing on the inside of the instrument.

<p>1. Serial Number Label (back panel)</p>	 <p>OPTICAL PARTICLE SIZER Model 3330 SN 3330110210 MFD JANUARY 2011 CLASS 1 LASER PRODUCT COMPLIES WITH 21 CFR 1040.10 AND 1040.11 TSI Inc. 500 Cardigan Road Shoreview, MN 55126 U.S.A. www.tsi.com</p>
<p>2. Laser Radiation Label (internal)</p>	<p>DANGER! VISIBLE LASER RADIATION WHEN OPEN. AVOID DIRECT EXPOSURE TO BEAM WARNING: NO USER SERVICEABLE PARTS INSIDE. REFER SERVICING TO QUALIFIED PERSONNEL</p>
<p>3. Filter label for 37-mm Cassette</p>	 <p>!!WARNING!! TSI FILTER, PART NUMBER 1130002 MUST BE USED TO PROTECT THE PUMP AGAINST PARTICLES</p>
<p>4. Battery label</p>	 <p>!!WARNING!! THIS INSTRUMENT WAS DESIGNED TO USE ONLY TSI SUPPLIED BATTERIES, PN 801680</p>
<p>5. Electrical Shock caution and no user serviceable parts (back panel)</p>	<p>CAUTION No user serviceable parts inside. Refer service to qualified personnel. To avoid electrical shock, the power cord protective grounding conductor must be connected to earth ground</p>
<p>6. Laser Instrument compliance label (back panel)</p>	<p>CLASS 1 LASER PRODUCT THIS PRODUCT IS IN COMPLETE COMPLIANCE WITH 21 CFR 1040, 10 AND 1040, 11</p>
<p>7. European symbol for non-disposable item. Item must be recycled.</p>	

Description of Caution/Warning Symbols

The following symbols and an appropriate caution/warning statement are used throughout the manual and on the Model 3330 to draw attention to any steps that require you to take cautionary measures when working with the Model 3330.

Caution



C a u t i o n
<p>Caution means <i>be careful</i>. It means if you do not follow the procedures prescribed in this manual you may do something that might result in equipment damage, or you might have to take something apart and start over again. It also indicates that important information about the operation and maintenance of this instrument is included.</p>

Warning



W A R N I N G
<p>Warning means that unsafe use of the instrument could result in serious injury to you or cause irrevocable damage to the instrument. Follow the procedures prescribed in this manual to use the instrument safely.</p>

Caution or Warning Symbols

The following symbols may accompany cautions and warnings to indicate the nature and consequences of hazards:

	Warns you that uninsulated voltage within the instrument may have sufficient magnitude to cause electric shock. Therefore, it is dangerous to make any contact with any part inside the instrument.
	Warns you that the instrument contains a laser and that important information about its safe operation and maintenance is included. Therefore, you should read the manual carefully to avoid any exposure to hazardous laser radiation.
	Warns you that the instrument is susceptible to electro-static discharge (ESD) and ESD protection procedures should be followed to avoid damage.
	Indicates the connector is connected to earth ground and cabinet ground.

Reusing and Recycling

The following symbols may accompany cautions and warnings to indicate the nature and consequences of hazards:



As part of TSI Incorporated's effort to have a minimal negative impact on the communities in which its products are manufactured and used:

- Do **not** dispose of used batteries in the trash. Follow local environmental requirements for battery recycling.
- If instrument becomes obsolete, return it to TSI for disassembly and recycling.

Contents

Manual History	ii
Warranty	iii
Safety	v
Labels.....	vi
Description of Caution/Warning Symbols	vii
Caution	vii
Warning	vii
Caution or Warning Symbols.....	vii
Reusing and Recycling.....	viii
About This Manual	xiii
Purpose.....	xiii
Related Product Literature	xiii
Submitting Comments.....	xiii
CHAPTER 1 Product Overview	1-1
Product Description.....	1-1
Applications.....	1-2
How the 3330 Operates.....	1-3
CHAPTER 2 Unpacking and System Setup	2-1
Packing List.....	2-1
Ventilation Requirements.....	2-3
Power Connection.....	2-4
Installing the Batteries	2-4
Using the AC Adapter to Run the Instrument	2-4
Battery Charging.....	2-5
Connecting a Computer	2-5
Printing.....	2-6
I/O Port.....	2-6
Wiring the Analog Output	2-6
Wiring the Alarm	2-7
CHAPTER 3 Description of the OPS Spectrometer	3-1
CHAPTER 4 OPS Spectrometer Operation	4-1
Screen Layout and Functionality	4-3
Main Tab.....	4-4
Setup Tab	4-6
System Setup Screen.....	4-8
Set Analog Out Signal	4-11
Field	4-11
Description.....	4-11
Device Setup Screen	4-12

Field.....	4-13
Description.....	4-13
Field.....	4-14
Description.....	4-14
Sampling Setup Screen.....	4-21
Field.....	4-24
Description.....	4-24
Field.....	4-32
Description.....	4-32
Field.....	4-34
Description.....	4-34
Field.....	4-35
Description.....	4-35
Data Tab.....	4-36
CHAPTER 5 Theory of Operation	5-1
Sample Flow Path.....	5-2
Optics Path	5-4
Concentration Calculation.....	5-4
CHAPTER 6 Maintenance	6-1
Maintenance Schedule	6-1
Cleaning the Inlet.....	6-2
Replacing the Internal Filters.....	6-3
Storage Precautions	6-6
Calibrating the OPS Spectrometer	6-6
APPENDIX A Model 3330 Specifications	A-1
APPENDIX B CSV File.....	B-1
APPENDIX C Troubleshooting.....	C-1
Technical Contacts	C-3
APPENDIX D Using Serial Data Commands.....	D-1
Communications	D-1
Commands.....	D-1
How to Input Commands and Troubleshoot the Results.....	D-2
Input Guidelines.....	D-2
Troubleshooting Input.....	D-2
Read Instrument Information.....	D-5
Set Up the Instrument.....	D-11
Place Instrument into a new State.....	D-19

Index

Reader's Comments

Figures

1-1	Model 3330 Optical Particle Sizer Spectrometer.....	1-2
2-1	Install Batteries	2-4
2-2	USB Port Connector on the Left Side of the Model 3330 OPS Spectrometer.....	2-5
2-3	4-pin mini-DIN Connector of the Model 3330 OPS Spectrometer.....	2-6
3-1	Model 3330 OPS Spectrometer Components Showing Inlet Nozzle, On/Off Button, Stylus, and Communications Connections.....	3-2
3-2	Analog/Alarm Output, USB Host, USB Device, and Ethernet Connections	3-3
3-3	Power Connector	3-3
3-4	Exhaust Port	3-4
4-1	Main Tab Screen	4-2
4-2	On-screen Keyboard.....	4-3
4-3	Instrument State Icons.....	4-6
4-4	Setup Tab Screen.....	4-6
4-5	Data Setup Screen	4-7
4-6	System Setup Screen.....	4-8
4-7	Flow Calibration Screen	4-9
4-8	Flow Calibration Screen with Keep Pump On Selected	4-10
4-9	Analog Out Screen	4-11
4-10	Device Setup Screen.....	4-12
4-11	Data and Time Setup Screen	4-13
4-12	Communications Screen	4-14
4-13	Display Screen.....	4-15
4-14	Information Screen	4-16
4-15	Diagnostics Screen.....	4-17
4-16	Diagnostics Screen with Pump ON all the Time.....	4-18
4-17	Self Check Screen at Beginning of Test.....	4-18
4-18	Self Check Screen.....	4-19
4-19	Self Check Error Screen.....	4-20
4-20	Self Check Screen Error Message Details	4-20
4-21	Sampling Setup Screen.....	4-21
4-22	Channels Screen	4-22
4-23	Edit Channel Dialog Screen	4-22
4-24	Index of Refraction Corrected Screen	4-23
4-25	User Calibration Screen	4-24
4-26	Scheduling Screen.....	4-25
4-27	Scheduling Screen—Sample Length: 00:01:00, Number of Samples: 10, Repeat Interval: 00:00:10, Number of Sets: 1	4-28
4-28	Scheduling Screen—Sample Length: 00:01:00, Number of Samples: 1, Repeat Interval: 00:00:01, Number of Sets: 10	4-28
4-29	Single File Setup Screen	4-29

4-30	Logging Data to a Single File	4-29
4-31	Scheduling Screen—Sample Length: 24:00:00, Number of Samples: 1, Repeat Interval: 01:00:00, Number of Sets: 10.....	4-30
4-32	Scheduling Screen—Sample Length: 01:00:00, Number of Samples: 24, Repeat Interval: 01:00:00, Number of Sets: 10.....	4-31
4-33	Scheduling Screen—Sample Length: 01:00:00, Number of Samples: 8, Repeat Interval: 01:00:00, Number of Sets: 5.....	4-31
4-34	Scheduling Screen: Sample Length: 00:00:01, Number of Samples: 30,000, Repeat Interval: 00:00:01, Number of Sets: 1.....	4-32
4-35	Alarms Screen	4-34
4-36	Protocol Screen	4-35
4-37	Protocol testP Screen.....	4-36
4-38	Data Tab Screen	4-36
4-39	Data Tab – Save Data Screen	4-37
4-40	Data Tab – Delete Data Screen	4-38
4-41	View Data Screen.....	4-39
5-1	Sample Flow Path in the OPS Model 3330.....	5-2
6-1	Unscrew Inlet Nozzle.....	6-2
6-2	Do NOT Blow into the Instrument.....	6-3
6-3	Pull out Single Cylindrical Filter from Filter Well	6-4
6-4	Open Blue Retention Clip.....	6-4
6-5	Remove 37-mm Filter Cassette.....	6-5
6-6	Open Filter using Supplied Tool.....	6-5
6-7	Checking Filter Holder to confirm that it is Fully Closed.....	6-5
D-1	Communications Screen—Use DHCP.....	D-3
D-2	E_NDIS Properties Screen.....	D-4

Tables

6–1	Recommended Maintenance Schedule	6-2
A-1	Model 3330 Optical Particle Sizer Specifications.....	A-1
C-1	Troubleshooting Symptoms and Recommendations	C-1
D-1	Troubleshooting Serial Commands	D-2

About This Manual

Purpose

This is an operation and service manual for the Model 3330 Optical Particle Sizer (OPS) Spectrometer.

Related Product Literature

- ***Aerosol Instrument Manager[®] Software for Optical Particle Sizers Manual*** (part number 6004402 TSI Incorporated)
- ***Model 3332 Dilution System Manual*** (part number 6004469 TSI Incorporated)
- ***Model 8535 Environmental Enclosure Manual*** (part number 6002097 TSI Incorporated)

Submitting Comments

TSI values your comments and suggestions on this manual. Please use the comment sheet, on the last page of this manual, to send us your opinion on the manual's usability, to suggest specific improvements, or to report any technical errors.

If the comment sheet has already been used, send your comments to:

TSI Incorporated
500 Cardigan Road
Shoreview, MN 55126
Fax: (651) 490-3824
E-mail Address: particle@tsi.com

(This page intentionally left blank)

CHAPTER 1

Product Overview

This chapter contains a product description of the Model 3330 Optical Particle Sizer (OPS) spectrometer and a brief description of how the instrument operates.

Product Description

The Model 3330 OPS spectrometer, shown in Figure 1-1, is a high-performance, general-purpose particle spectrometer that measures aerosol optical diameter. The Model 3330 provides accurate count size distributions for particles with optical diameters from 0.3 to 10 micrometers (μm).

The Model 3330 can be operated and collect data in two modes:

- Connected to a computer with Aerosol Instrument Manager[®] software installed to provide computer controlled operation, data collection/interpretation, data importing/exporting, and printing.
- Stand-alone mode, logging data to internal memory which can be viewed on the front panel or saved to an external USB flash thumb drive and imported at a later time into Aerosol Instrument Manager[®] software for full data analysis.

The Model 3330 has a touch-sensitive (touchscreen) LCD display. Using the touchscreen you can display and change settings as well as select functions and read operating parameters from menus displayed on the screen. Functions include start, stop, and length of measurement; parameters include inlet pressure, flow rate, and temperature. During the sampling process, the size distribution is shown on-screen in real time. You can also view the information for a specific channel of the instrument including concentration, particle size, and total particle count.



Figure 1-1
Model 3330 Optical Particle Sizer Spectrometer

Applications

The Model 3330 OPS spectrometer has application in the following areas:

- Filter testing (i.e., ASHRAE 52.2)
- Indoor air quality
- Work place studies
- Outdoor environmental monitoring
- Industrial measurements
- Basic Aerosol Research
- Emissions monitoring & control
- Many other aerosol related research topics

How the 3330 Operates

The OPS 3330 works on the principle of optical scattering from single particles. Particles are illuminated using a laser beam shaped to a thin sheath focused below the inlet nozzle. As particles pass through this light sheath, they scatter light in the form of pulses that get counted and sized simultaneously. The concentration measured by the OPS is sensitive to the flow rate and hence the flow is tightly controlled to 1.0 L/min \pm 5%. There is also a separate sheath flow at 1.0 L/min that keeps the particles tightly confined to the sensing volume. The sheath flow is completely internal to the instrument; the exhaust of the pump is HEPA filtered and recirculated back into the chamber to provide sheath flow. Two pressure transducers monitor the aerosol flow and the sheath flow and adjust the pump voltage to maintain the flows within their specifications.

Particle pulses are sized and binned in up to the 16 different channels (Note: Channels are user configurable and can be reduced or increased to a maximum of 16 channels). Pulse heights are proportional to the optical particle size. Through calibration using different monodispersed uniformly spherical Polystyrene Latex particles (PSL), different pulse heights are related to different particle sizes.

Ideally, only one particle will be in the sensing volume at one time. However, if concentration is increased high enough, more than one particle will be in the sensing volume. When that happens, coincidence occurs, which results in a drop in counting efficiency and particles are sized into the wrong channels. Diluters are commonly used upstream of an OPS to reduce concentration at the inlet of the instrument.

Refer to Chapter 5, "[Theory of Operation](#)," for a detailed description.

(This page intentionally left blank)

CHAPTER 2





Unpacking and System Setup









This chapter provides information concerning the accessories shipped with the instrument and describes basic setup procedures.

Packing List

Table 2-1 provides a packing list of all items that should have been shipped to you as the OPS spectrometer and accessory kit. Please compare the list to the items you received. If any items are missing, notify TSI immediately.

Table 2-1
Packing List

Qty	Part Number	Description	Item
1	3330000	Model 3330 Optical Particle Sizer Spectrometer	
1	801670	Carrying Case	
1	7001911	Aerosol Instrument Manager® Software CD-ROM. Contains the installation guide and the Aerosol Instrument Manager Software for Optical Particle Sizer (OPS) Spectrometers User's Manual.	
1	800663	Zero Filter	

Qty	Part Number	Description	Item
1	801680	6600 mAh Lithium Ion Rechargeable Battery	
1	1303740	USB cable (2 m)	
1	801652	Analog/alarm output cable	
1	6004403	Model 3330 Optical Particle Sizer Spectrometer Operation and Service Manual (this manual)	
1	6004814	Model 3330 Optical Particle Sizer Spectrometer Quick Start Guide	
1	N/A	Calibration Certificate	
1	801688	Conductive Tubing; 24 in; 5/16 x 3/16	
1	801668	Filter removal tool (Spanner Driver)	

Qty	Part Number	Description	Item
4	1130006	Spare Internal Filter Elements	
1	1130002	37-mm filter cassette includes: Filter body top Filter body bottom 37-mm glass fiber filter Stainless Steel Mesh Screen	
1	7001303	37-mm cartridge opening tool	
1	801692	External AC adapter with adapters for various plug types)	
2	1319420	Stylus; When shipped, one stylus will be in the accessory bag, the second stylus is attached to instrument.	

Ventilation Requirements

The Model 3330 OPS spectrometer requires no special mounting requirements.

The spectrometer cabinet is designed to be cooled by room air. Sampled air is exhausted from the bottom of the cabinet near the back.

The cabinet should be placed on a clean, hard surface where there is at least a 4-inch (100 mm) clearance between the back panel and any other surface so that the exhaust air can move freely from the cabinet. The sides should also have at least 3-inch (75 mm) clearance between the cabinet and any other surface to allow for cable connections.

Power Connection

The Model 3330 OPS may be powered using the supplied rechargeable lithium-ion battery (installing an optional second battery provides longer operation) or using the external AC adapter.



WARNING

The instrument has been designed to be used with batteries supplied by TSI. Do **not** use a substitute.

Disposing of old batteries must be recycled in accordance with the local environmental regulations.

Do **not** use non-rechargeable batteries in this instrument. Fire, explosions, or other hazards may result.

Removing/changing the lithium-ion battery or disconnecting AC power may cause a small amount of lost data; typically less than one minute's worth if full power is removed from the instrument. However, if one good source of power is available, the other can be applied and removed without interrupting the unit.

Installing the Batteries

To install the batteries, remove the battery cover and slide one or two batteries into the battery slots. A single battery can be put into either slot. Orient the batteries with the label side facing up (see Figure 2-1).



Figure 2-1
Install Batteries

Using the AC Adapter to Run the Instrument

The AC adapter lets you power the OPS from an AC wall outlet. When using the AC adapter, the batteries (if installed) are bypassed. If AC power is lost; however, the batteries will operate the instrument until AC power is restored or the batteries are depleted.

Battery Charging

The instrument charges the Lithium Ion battery pack whenever the AC adapter is plugged into the instrument and the instrument is in stand-by mode. Batteries are not charged if the instrument is turned off or is actively taking measurements. Charging stops when the batteries are fully charged.



WARNING

When Charging Battery the ambient temp must not exceed 45°C

Connecting a Computer

Connect the OPS to a computer using the 2-meter USB cable provided with the unit. Connect the USB port of the computer to the USB connector on the left side of the Model 3330 (Figure 2-3).

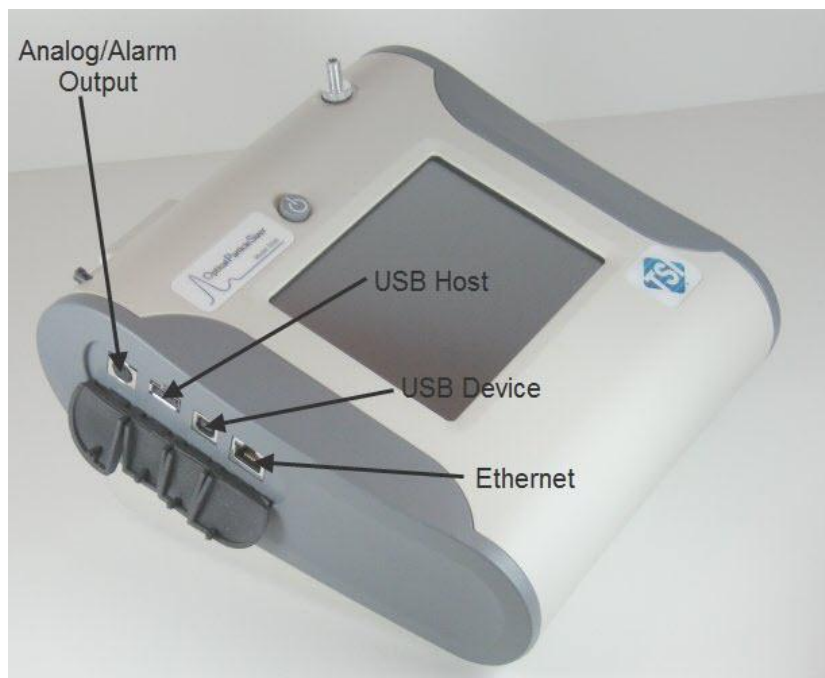

Figure 2-2
USB Port Connector on the Left Side of the Model 3330 OPS Spectrometer

Printing

The Model 3330 has no print function, so you cannot print information directly from the instrument. Use the Model 3330 module of the Aerosol Instrument Manager[®] software to manage data files and print out reports, graphs, etc.

I/O Port

The OPS spectrometer has a 4-pin, mini-DIN connector port (Figure 2-4) for connecting the analog/alarm output cable. The pin-outs for the connector and the wiring for the cable are shown below.

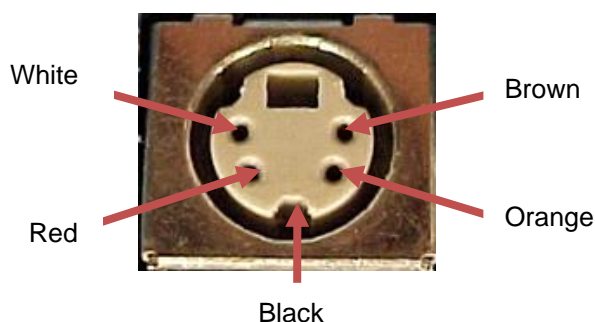

Figure 2-3
4-pin mini-DIN Connector of the Model 3330 OPS Spectrometer

Cable Wiring Diagram	
Brown Wire	Analog Ground
Orange Wire	Analog Out
Red Wire	Alarm (+)
White Wire	Alarm (-)
Black Wire	Shield

Wiring the Analog Output

- Output voltage: 0 to 5 VDC. With a maximum output of 15 mA
- Output Current 4 mA to 20 mA with a maximum load impedance of 250 ohms.
- Correct polarity must be observed (see pin-outs above).

The output cable supplied is labeled with the pin-out wiring diagram. Additional equipment may be needed for making connections to the system. It is your responsibility to specify and supply all additional equipment.

Wiring the Alarm

System specifications:

- Maximum voltage: 30 VDC (**DO NOT USE AC POWER**)
- Maximum current: 2 Amp
- Correct polarity must be observed (see pin-outs above)
- The alarm out connection is rated for a 30 VDC insulation



W A R N I N G

The monitor Alarm Output function should **not** be used to detect hazardous conditions or to provide an alarm for protecting human life, health, or safety.



C a u t i o n

The alarm switch must not be wired to AC power! Failure to properly install the user alarm could damage the instrument and/or void the instrument warranty! Please read and follow all instructions before wiring or operating the user alarm.



W A R N I N G

When connected to the analog out and alarm out connector, you must use safety certified equipment and/or power sources.

(This page intentionally left blank)

CHAPTER 3

Description of the OPS Spectrometer

This chapter describes the components of the Model 3330 Optical Particle Sizer (OPS) spectrometer (see Figure 3-1).

The front-panel LCD display provides continuous real-time sampling information and access to the menus for system operation. A plastic stylus, for use with the touchscreen interface, locks into place in the case near the top of the unit when not in use.



Caution

Use your fingertip or the stylus only. Do **not** use sharp objects, such as pens or pencils, on the touchscreen as they may damage it.



Caution

If you are attaching the inlet of the OPS to a particle generator or test duct that has positive pressure, you should have the OPS pump turned on before connecting to the generator or duct. This can be accomplished by starting a sample prior to attaching tubing to the OPS inlet nozzle or by using the "Keep Pump On" mode (see Note below). The OPS is protected against contamination using sheath flow technology. If particles are introduced into the instrument without first having the pump running (by starting a sample), then the optics chamber is at risk of becoming contaminated, and/or the unit may not be able to start the measurement because of high background scattering light. Similarly, make sure you disconnect the inlet from the particle generator while the OPS pump is still running.

Note

In order to avoid the problem described above, the OPS pump can be configured to run continuously. In "Keep Pump On" mode, the OPS pump is always running any time the unit is turned ON. Use discretion when enabling "Keep Pump On" mode as the pump life will be reduced if the OPS pump is left running all the time. For applications where the unit is connected to a test duct, TSI recommends that "Keep Pump On" mode be enabled. Further details regarding "Keep Pump On" mode can be found in the manual under **Setup | System | Flow Calibration**. This also affects the diagnostics screen under **Setup | Device | Diagnostics**.



Figure 3-1
Model 3330 OPS Spectrometer Components Showing Inlet Nozzle, On/Off Button, Stylus, and Communications Connections

Although you may want to use the Aerosol Instrument Manager[®] software to display, collect, save, and print data, this display provides a local interface to the instrument and allows the user to change settings and display data in various formats at the instrument itself.

The inlet nozzle, and the on/off button are also accessed from the front of the unit.

The left side panel provides communications connections, and the right side provides a power connector for the AC adapter.

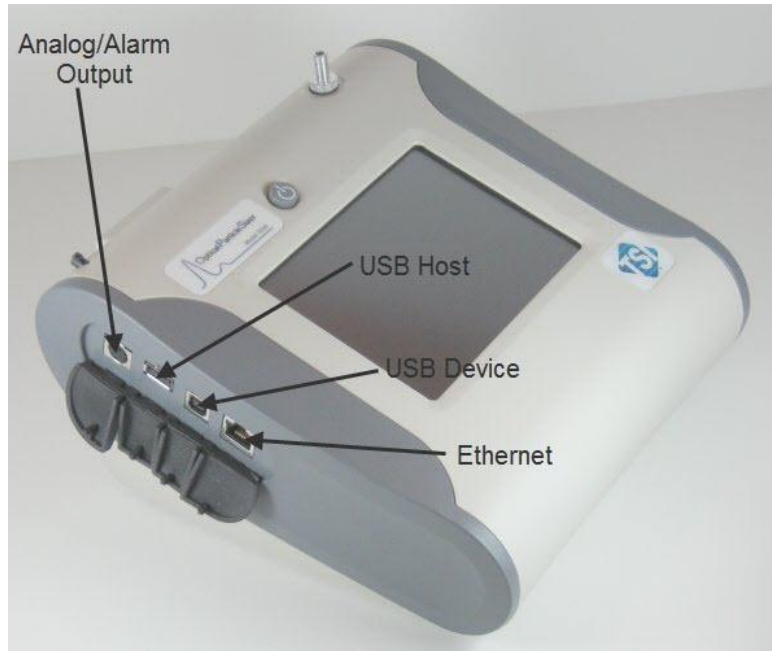

Figure 3-2
Analog/Alarm Output, USB Host, USB Device, and Ethernet Connections



Figure 3-3
Power Connector

Internal components consist of the flow system, the optics system, and the signal processing electronics.

The inlet nozzle on the top of the Model 3330 is designed so that aerosol can be sampled from a chamber or open air with good efficiency. Tubing can be attached to the inlet to sample when necessary. The inlet is 0.25 inches (6.35 mm) in diameter for use with ¼-inch Swagelok®-type connectors or with slightly smaller inner diameter flexible tubing.

Note: *Conductive tubing is recommended for use with the OPS spectrometer to minimize particle loss due to electrostatic charge. Suitable tubing is supplied with the 3330 and additional tubing is available from TSI.*

Sample aerosol is exhausted through the Exhaust Port on the bottom of the instrument (see Figure 3-4).

The pump exhaust connector is a 0.25 diameter connector that allows connection to the exhaust flow. The exhaust can be vented to a hood or connected in line to equalize pressure when sampling from a chamber or in an aircraft. The exhaust flow is 1.0 L/min. Make certain the exhaust tube allows the exhausted sample to flow freely (check for crimps and constrictions).



Figure 3-4
Exhaust Port

If the aerosol sample is exhausted without tubing, make sure you do **not** block the Pump Exhaust.

The only serviceable components of the Model 3330 OPS spectrometer are the inlet nozzle and the filters, which require routine maintenance (refer to [Chapter 6](#)).

®Swagelok is a registered trademark of Swagelok® Companies, Solon, Ohio.

CHAPTER 4

OPS Spectrometer Operation

This chapter describes how to operate the Model 3330 using the interface provided through the touchscreen. To operate the instrument using the Aerosol Instrument Manager[®] software for OPS spectrometers, refer to the manual for that software (TSI P/N 6004402).



Caution

Use your fingertip or the stylus only. Do **not** use sharp objects, such as pens or pencils, on the touchscreen as they may damage it.



Caution

If you are attaching the inlet of the OPS to a particle generator or test duct that has positive pressure, you should have the OPS pump turned on before connecting to the generator or duct. This can be accomplished by starting a sample prior to attaching tubing to the OPS inlet nozzle or by using the "Keep Pump On" mode (see Note below). The OPS is protected against contamination using sheath flow technology. If particles are introduced into the instrument without first having the pump running (by starting a sample), then the optics chamber is at risk of becoming contaminated, and/or the unit may not be able to start the measurement because of high background scattering light. Similarly, make sure you disconnect the inlet from the particle generator while the OPS pump is still running.

Note

In order to avoid the problem described above, the OPS pump can be configured to run continuously. In "Keep Pump On" mode, the OPS pump is always running any time the unit is turned ON. Use discretion when enabling "Keep Pump On" mode as the pump life will be reduced if the OPS pump is left running all the time. For applications where the unit is connected to a test duct, TSI recommends that "Keep Pump On" mode be enabled. Further details regarding "Keep Pump On" mode can be found in the manual under **Setup | System | Flow Calibration**. This also affects the diagnostics screen under **Setup | Device | Diagnostics**.

To turn on the instrument:

1. Apply power either using the AC adapter or install the batteries.
2. Press the **On/Off** button.

After a splash screen displays the TSI logo, a brief start-up sequence begins as the system boots up.

The instrument is ready for operation when the Main tab (Figure 4-1) appears.

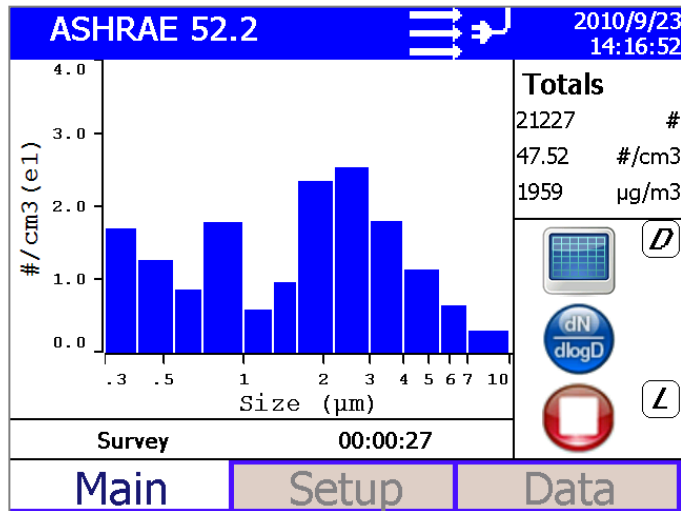

Figure 4-1
Main Tab Screen

Screen Layout and Functionality

There are three main screens (tabs): Main, Setup, and Data. The operation of each of these screens, the information displayed on them, and the functions that can be performed from each are described in the remainder of this chapter.

Some screens require or allow you to enter information. To enter information, tap on the screen in an editable field and an on-screen keyboard appears (Figure 4-2). Use the stylus (or your finger) to enter the information and then press the **Enter** (or return ↵) key. To exit the on-screen keyboard use the **Esc** key.











Figure 4-2
On-screen Keyboard

Main Tab

The Main Tab is the default screen. The left side of the screen presents either a graph or table of the most recent particle size data.





The status bar at the top of the screen shows the name of the current data set, the current time and date settings (see the [Setup Tab](#)) and indicates:

Icon	Description
	An error has occurred. Click on this icon to review which error has occurred and refer to the Appendix B for more information.
	Sufficient flow through the Model 3330.
	Insufficient flow through the Model 3330.
	Operating on AC power, no battery installed.
	Operating on AC power, battery is installed and not charging.
	Operating on battery power and the battery is fully charged.
	Operating on battery power and the Battery is ¼ or less charged. When the battery is charging, the icon is animated and changes every second, cycling through all the battery level icons.
	Operating on battery power but the Battery is so low the instrument will turn off within 5 minutes. An on-screen message is displayed to warn you that the instrument will shut down in approximately 5 minutes.
	An alarm has been triggered. If the alarm is audible, click on this icon to disable the buzzer.

The right side of the Main Tab shows the:

- Total number of particles counted.
- Total number concentration in particles per cubic centimeter ($\#/cm^3$).
- Total particle mass concentration in micrograms per cubic meter ($\mu g/m^3$).

The icons below these totals let you:

- Switch between displaying data in a graph  or table .
- Display data using one of the following units
 - Text display
 - dC; Counts
 - dW; Number and Mass Concentration
 - dW/dD; Number and Mass Concentration Linearly Normalized
 - dW/dLogD; Number and Mass Concentration Logarithmically Normalized
 - Graph Display
 - dC; Counts
 - dN; Number Concentration
 - dM; Mass Concentration
 - dN/dD; Number Concentration Linearly Normalized
 - dM/dD; Mass Concentration Linearly Normalized
 - dN/dLogD; Number Concentration Logarithmically Normalized
 - dM/dLogD; Mass Concentration Logarithmically Normalized
- Start  and stop  data collection.
- The instrument state icons are:
 - “D”; Dead Time Correction is enabled
 - “U”; User Calibration (Index of Refraction) is enabled
 - “A”; Alarm is enabled
 - “L”; Logging is enabled
 - “AO”; Analog Out is enabled

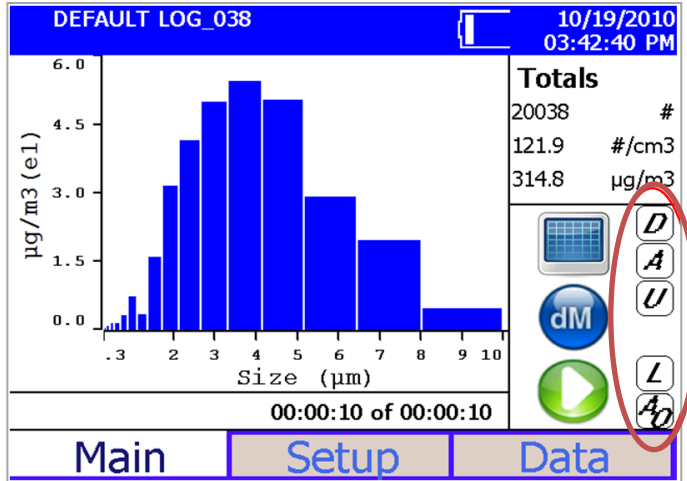

Figure 4-3
Instrument State Icons

Setup Tab

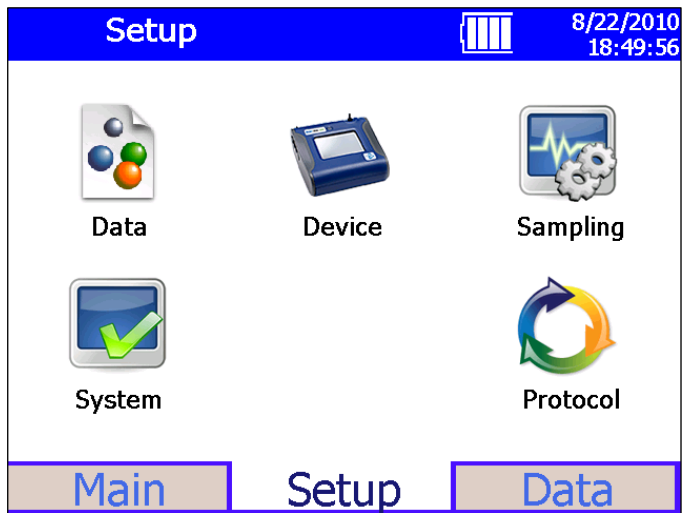

Figure 4-4
Setup Tab Screen

The setup tab lets you set up operations for the following:

Data	Save and clear all logged data and reset the protocol list.
System	Change the flow rate and set the analog out device.
Device	Set the date and time, recalibrate the touchscreen display, set up communications, and view important information about the system.
Sampling	Set up how sampling is displayed and handled. Set alarm thresholds, user calibration, define a new set of channel boundaries, and manipulate the protocols.
Protocol	Save a group of settings (protocols) that you use often so you do not have to reset individual settings.

Data Setup Screen

This screen lets you save logged data to a flash drive or clear logged data in the instrument.

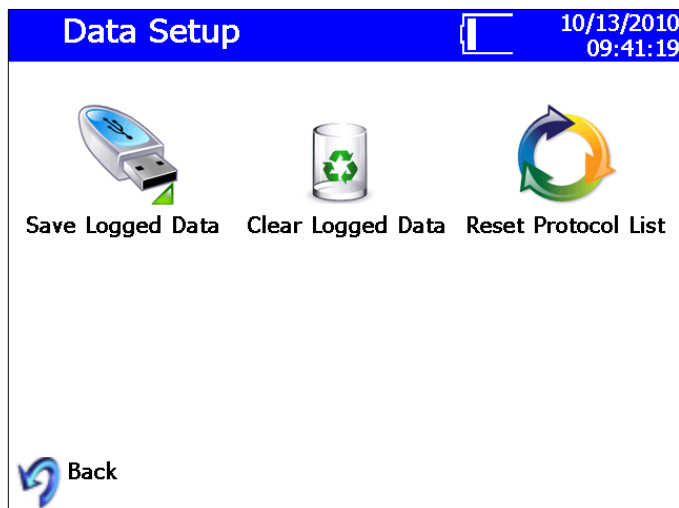

Figure 4-5
Data Setup Screen

To Save Logged Data to a Flash Drive

1. Insert a flash drive in the USB port.
2. Select **Save Logged Data**.
3. Verify that you want to save all samples by selecting **OK**.

The samples are saved to the flash drive and a message indicates the operation has completed successfully; the operation can take several minutes depending upon how much data you are saving. See [Appendix B](#) for a description of the information saved and the format of the .csv files.

The instrument verifies there is at least 5 MB is available on the flash drive before allowing the save to begin.

To Clear Logged Data from the Instrument

1. Select **Clear Logged Data**.
2. Verify that you want to clear all sample data by selecting **Yes**.

The data is removed and a message indicates the operation has completed successfully.

To Reset the Protocol List on the Instrument

1. Select **Reset Protocol List**.
2. Verify that you want to reset the list data by selecting **Yes**.

The list of protocols will be reset and contain only the factory default protocols. A message appears to indicate the operation has completed successfully.

System Setup Screen

From the System Setup screen you can calibrate the flow rate and set the analog out device.

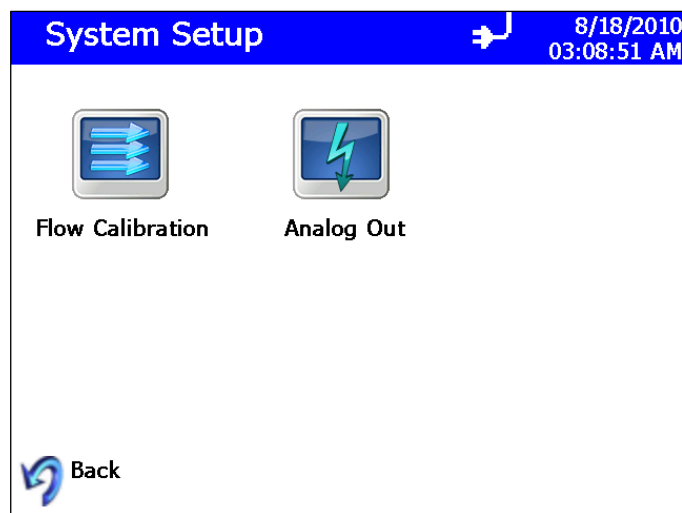

Figure 4-6
System Setup Screen

Flow Calibration

This screen is used in conjunction with a flow meter to calibrate flow through the instrument and to select the “Keep Pump On” function.

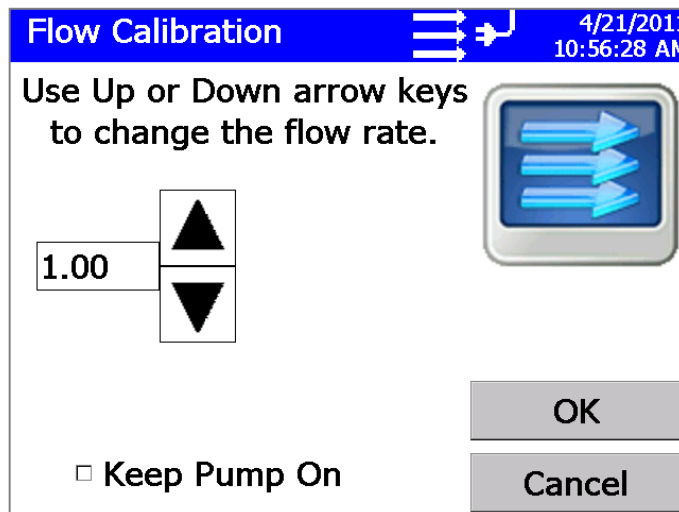

Figure 4-7
Flow Calibration Screen

To calibrate the flow:

1. Verify the instrument is on and there is flow through the instrument.
2. Attach a flow meter to Inlet Nozzle. The flow meter should read about 1.00 L/min.
3. If it does not, adjust flow using the up and down arrows until it reads 1.00 L/min.
4. Press **OK**.

This screen is also used to set the mode in which the pump is operated when the unit is turned ON, but not sampling (idle). Checking the “Keep Pump On” option allows the OPS pump to run all the time even when the OPS is not sampling. This feature is particularly useful when the OPS is sampling from a duct or other applications where aerosol is being forced into the OPS, which may contaminate the chamber if the pump is not running. Keeping the pump running all the time allows for sheath flow to be present all the time irrespective of whether the OPS is sampling or not. Use discretion when keeping the pump running continuously as the pump life will be reduced if the pump is left running all the time. To activate the option to run the pump at all times, click the check box next to “Keep Pump On” as shown below.

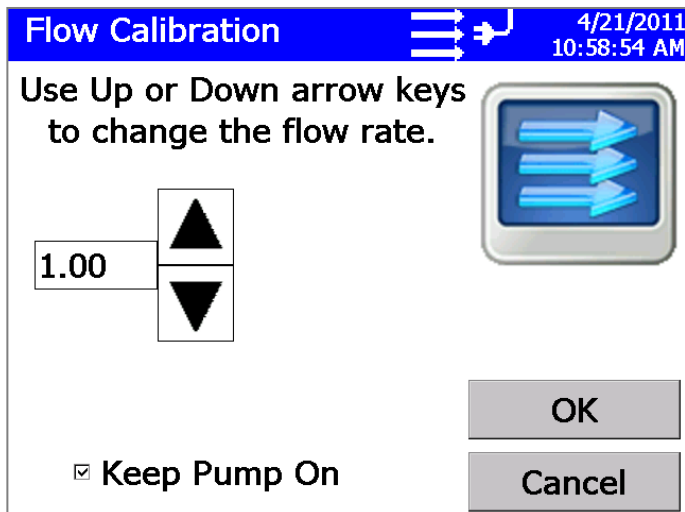

Figure 4-8
Flow Calibration Screen with Keep Pump On Selected

This also affects the diagnostics screen under **Setup | Device | Diagnostics**. Further details on this mode of operation are described under the [Diagnostic Screen](#) section.

Notes

- The “Keep Pump ON” option is stored as part of a Protocol on the OPS.
- If a self check fails, the “Keep Pump ON” option will be automatically disabled. You will need to re-enable “Keep Pump On” after addressing the cause of failure.
- The status bar will indicate flow state and errors on all screens except for the DATA tab. Errors will not be reported until leaving the Data tab.
- In the event of a flow error when the OPS is in the “Keep Pump ON” mode, the “Keep Pump ON” will be automatically disabled.

Set Analog Out Signal

The Analog Out screen lets you set up the analog output signal using the 4-pin, mini-DIN connector port and the analog/alarm output cable (see [I/O Port](#)). Press **OK** when done.

Figure 4-9
Analog Out Screen

Field	Description
Enable	Click to enable the analog output signal.
Type	Select the type of output; 0 to 5 V or 4 to 20 mA.
Units	From the dropdown list, select the units of the Range. Options are: total particles per cubic centimeter, #/cm ³ ; total micrograms per cubic meter, µg/m ³ .
Range	Min: Set the minimum reading that will correspond to 0 V or 4 mA. Max: Set the maximum reading that will correspond to 5 V or 20 mA.

Device Setup Screen

The Device Setup screen lets you set the date and time, recalibrate the touchscreen display, set up communications, view important information about the system, and access diagnostic information.

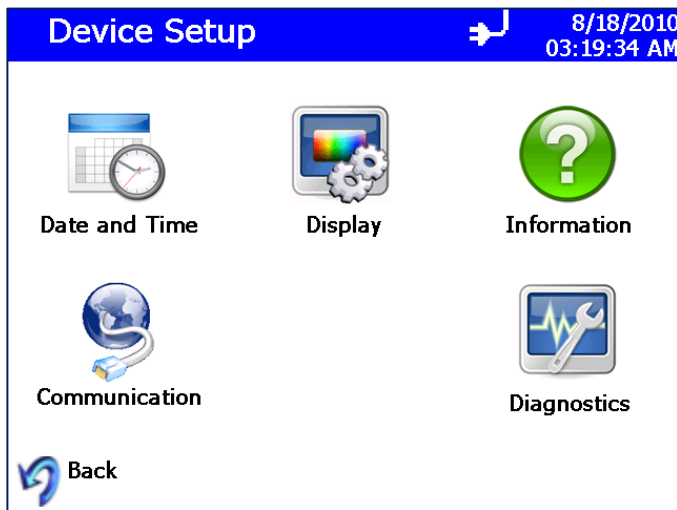

Figure 4-10
Device Setup Screen

Date and Time Setup

This screen lets you set the current date and time and set the date format. You can select options using the arrows or by tapping on the screen and entering data. Press **OK** when finished.

Figure 4-11
Data and Time Setup Screen

Field	Description
Date	Press the down arrow to display a calendar and then select the date from the calendar.
Time	Select the time component you want to change (hours; minutes; seconds) and then use the left and right arrows to adjust to the current time.
24 Hour	Check this box to display time in 24-hour format.
Date Format	Highlight the date format you want to use from the list.

Communications Screen

This screen lets you select how the instrument is configured for communication. You can manually set the IP Address, Subnet Mask, and Default Gateway or you can allow the system to use DHCP (Dynamic Host Configuration Protocol) to configure the device automatically. Press **OK** when done.

Any change in this screen requires the unit to be rebooted in order for the action to take effect.

The screenshot shows the 'Communications' screen with a blue header. The date and time '10/13/2010 09:55:16' are in the top right. A checked box labeled 'Use DHCP' is at the top left. Below it are three input fields: 'IP Address' with the value '010 .001 .012 .015', 'Subnet Mask' with '255 .255 .255 .000', and 'Default Gateway' with '010 .001 .012 .254'. To the right of these fields is an icon of a globe with a network cable. At the bottom left, 'USB IP Address' is displayed as '169.254.63.65'. At the bottom right are 'OK' and 'Cancel' buttons.

Figure 4-12
Communications Screen

TSI recommends that you connect the unit to a DHCP enabled router; if DHCP is not used, an IT specialist may be needed to set up the IP Address, Subnet Mask, and Default Gateway.

The USB IP Address is a static address.

See [Appendix D Using Serial Data Commands](#) to see how to communicate with the unit.

Field	Description
Use DHCP	Check this box to automatically configure communications with the OPS using DHCP.
IP Address	Enter the IP Address you want to assign the OPS to.
Subnet Mask	Enter the Subnet Mask you want to assign the OPS to.
Default Gateway	Enter the Default Gateway you want to assign the OPS to.
USB IP Address	Displays the USB IP Address of the OPS assigned by the NDIS driver; you cannot change this address.

Display Screen

This screen lets you reset the touchscreen alignment. This may be necessary when you go to touch a particular part of the screen and nothing happens or something unexpected happens. The touchscreen may not be calibrated correctly.

To recalibrate the screen alignment, press the **Screen Alignment** icon and follow the on-screen directions. For best results, use the stylus during recalibration.

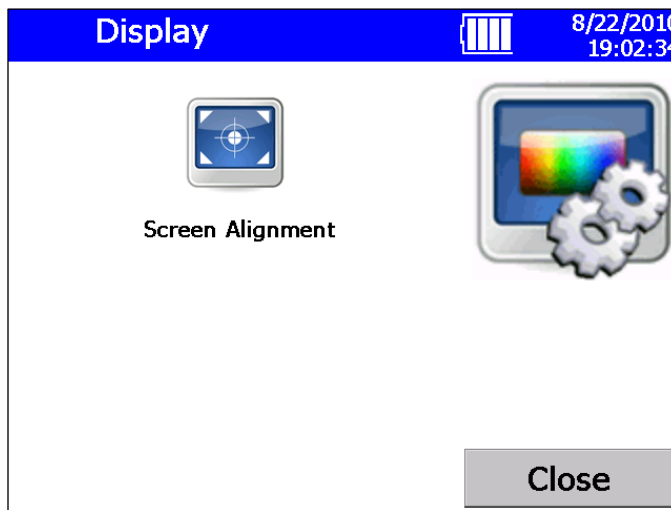

Figure 4-13
Display Screen

Information Screen

This screen lets you view information about the OPS and reset the date on which the filter was replaced. The information displayed includes: the system's model number, serial number, manufacturer, last calibration date, firmware version, and more. Press **Close** when finished.

The cylindrical filter in the instrument needs to be changed periodically. When you change the filter, click **Reset Filter Date** on this display to set the Filter Changed Date to the current date and reset the Filter Load value.

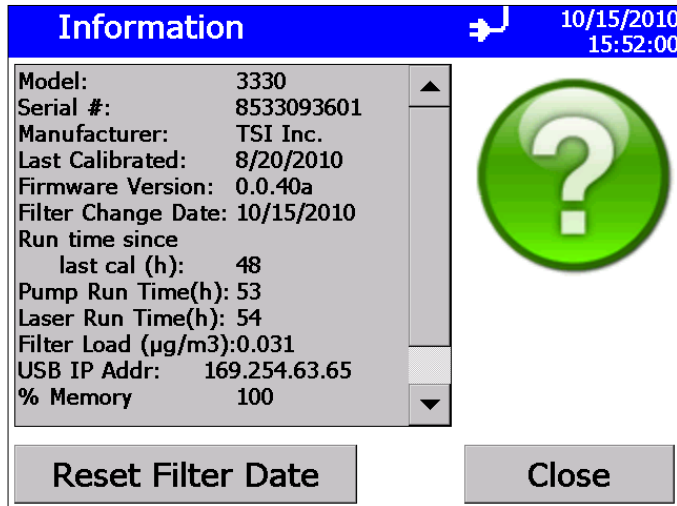

Figure 4-14
Information Screen

Diagnostic Screen

Access this screen when working with a TSI technician to diagnose problems with your instrument. The information displayed on this screen is intended for diagnosing problems only.

Note: *The Humidity (%) is currently only a placeholder for future upgrades. Hence, humidity will be displayed as 0.0 all the time and does not represent the actual humidity of the sampling air.*

Press **Exit** when finished.

The Diagnostics Screen will have a slightly different appearance depending on whether the “Keep Pump On” function (see section on Flow Calibration under **Setup | System | Flow Calibration**) has been chosen or not. The following figure shows the appearance when “Keep Pump On” has **not** been checked. Pressing the **Start Flow** button will start the pump and measured flow values will be shown and the “Start Flow” button is replaced by a “Stop Flow” button.

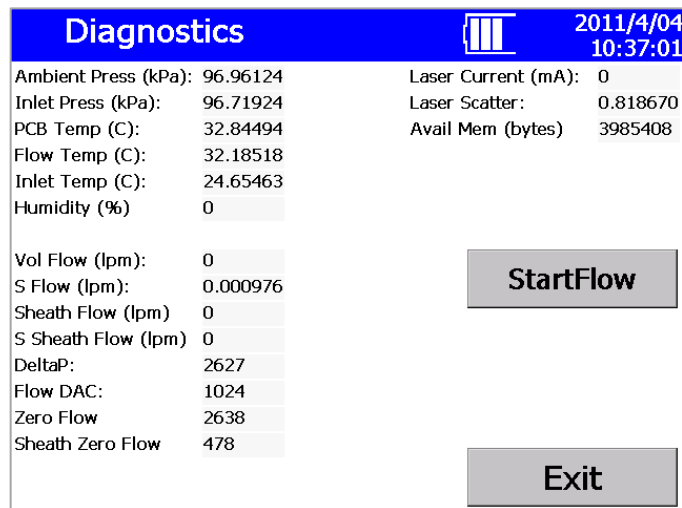

Figure 4-15
Diagnostics Screen

If the “Keep Pump On” option is enabled (see section on Flow Calibration under **Setup | System | Flow Calibration**), the diagnostics screen looks different. The “Self Check” button takes the place of the “Start Flow” button, as shown below.

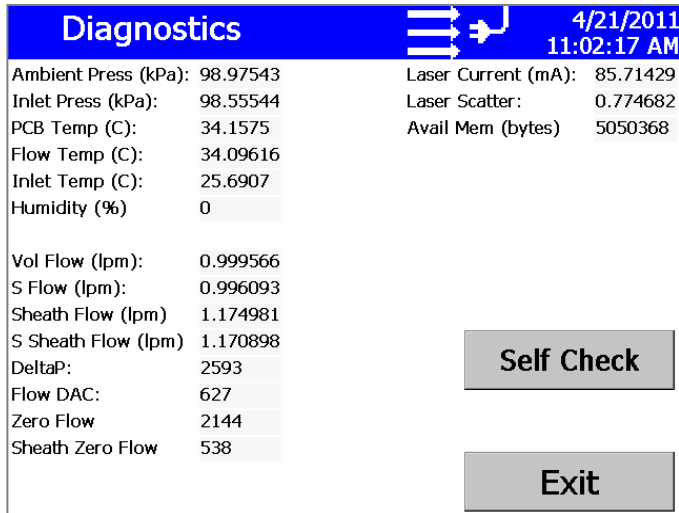

Figure 4-16
Diagnostics Screen with Pump ON all the Time

When the “Keep Pump On” option has been chosen, the OPS will do a Self Check (read Laser Scatter background zero) each time it is turned on but will not do that test before each sample (as it does when “Keep Pump On” is **not** selected).

You can also zero the OPS by going to this **Setup | Device | Diagnostics** menu and selecting the **Self Check** button. To start the “Self Check”, connect a zero filter (800663) to the inlet before starting the test (see figure below).

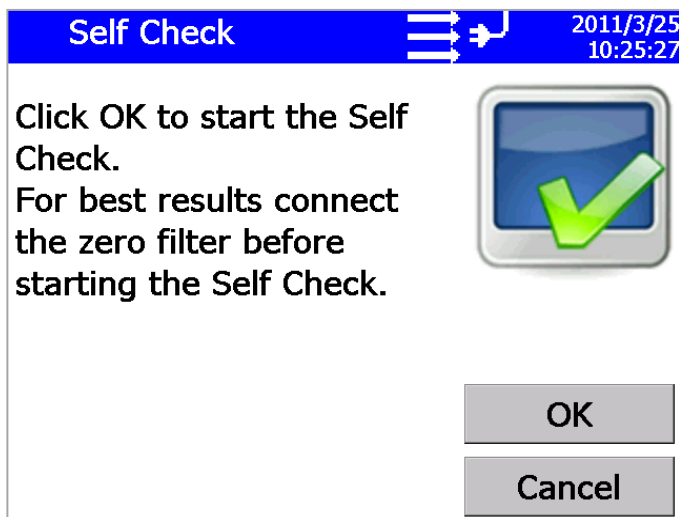

Figure 4-17
Self Check Screen at Beginning of Test

Note

The “Self Check” can be run without the zero filter as long as the sampled air is not too dirty. However, TSI recommends performing the “Self Check” with a zero filter attached to the inlet. During the “Self Check” the photodiode background noise level is determined. In absence of a zero filter, if the sampled air has too many particles, they tend to increase the background noise level higher making it harder for electronics to measure individual particle pulses. “Self Check” cannot be performed if the pump is set to run only during sampling. Under these settings, the “Self Check” is automatically performed during the start of each test.

A flow error may occur if the OPS cannot pull 1.0 L/min through the zero filter or if the tubing is pinched.

If a “Self Check” is initiated with or without a zero filter at the inlet, the test takes only a few seconds. If the OPS was able to set the photodiode background noise level appropriately, the test will complete and the OK button will be grayed out as shown below.

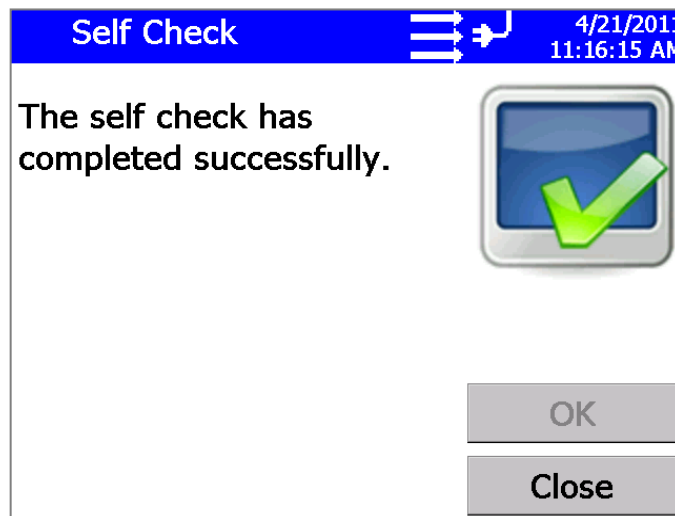

Figure 4-18
Self Check Screen

If too much background light is in the chamber, either because a zero filter was not used or the chamber was contaminated with particles, the following error will be displayed.

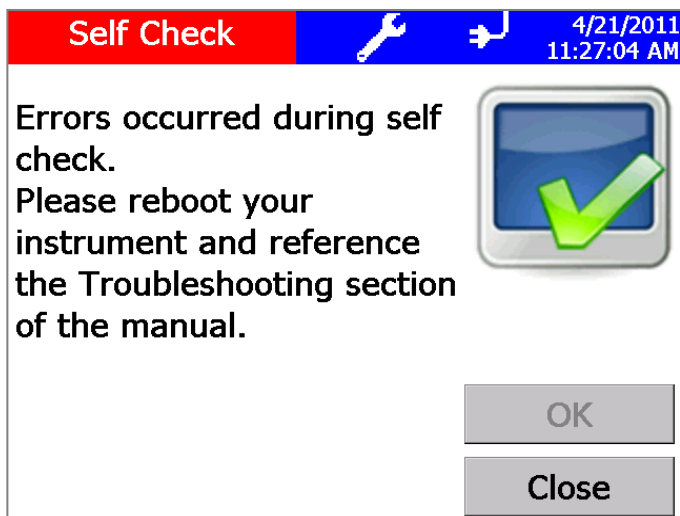

Figure 4-19
Self Check Error Screen

Clicking on the “wrench” symbol in this menu or the main menu will display further details as shown in the figure below.

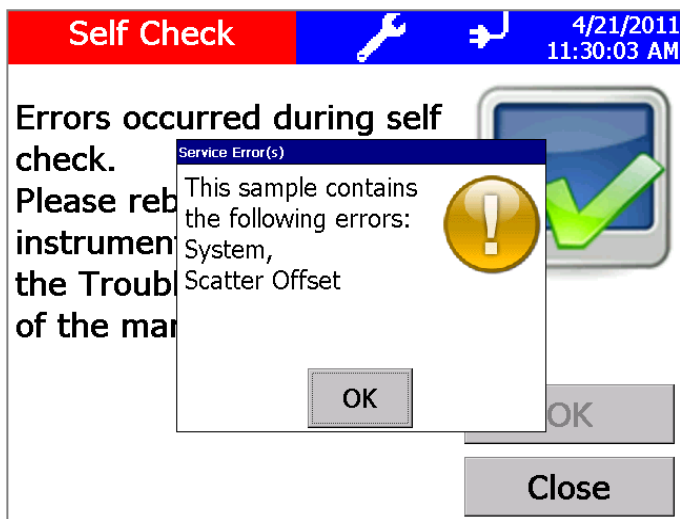

Figure 4-20
Self Check Screen Error Message Details

Retry the “Self Check” test. If it still comes up with an error, contact TSI. The optics chamber may be contaminated with particles.

Sampling Setup Screen

Use this screen to access screens that let you set up how sampling is displayed and handled. You can define the channels you want to use, the sampling schedule, user calibration, manipulate the protocols, and set alarm thresholds.

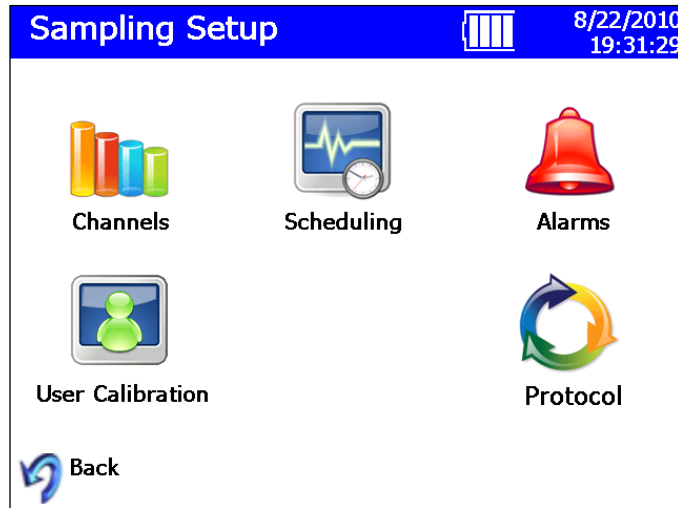

Figure 4-21
Sampling Setup Screen

Channels Screen

This screen leads you through a procedure to choose the number of channels you want to use and to set up parameters for each channel. (Channel setup can also be done using the Aerosol Instrument Manager[®] software.)

The first dialog to appear is shown below. Enter the number of channels you want to use and press **Edit**.

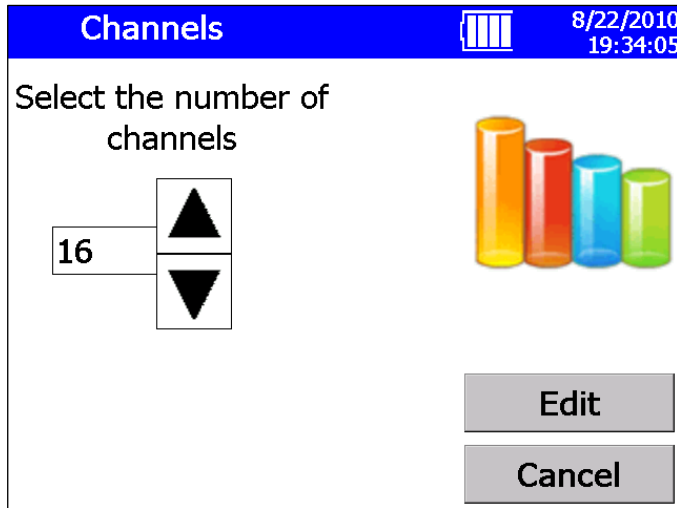

Figure 4-22
Channels Screen

The Edit Channel dialog for the first channel appears as shown below.

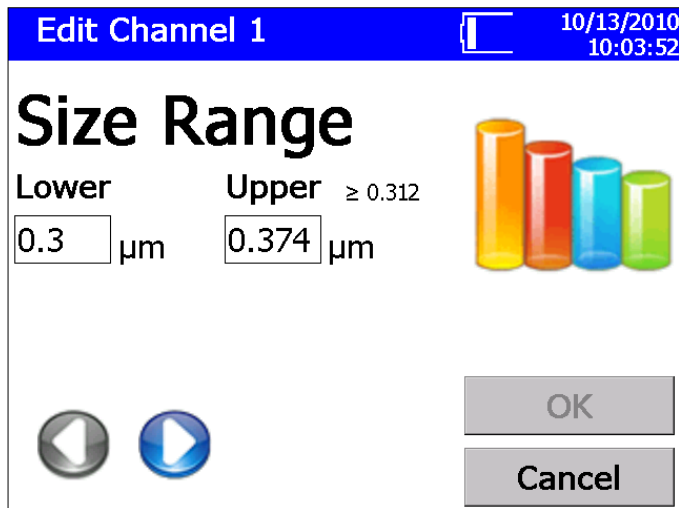



Figure 4-23
Edit Channel Dialog Screen

Enter the lower and upper size range for the first channel, then press , which will display the second channel edit screen.

Edit the lower and upper range for each channel until all channels have been edited, and then press **OK**. Channels cannot be set below 0.3 or above 10.0 μm and must be contiguous; they may not overlap one another. Therefore, the lower range value is filled in automatically. Each channel's size range is restricted. As shown in the figure above, for a Lower range of the 0.3, the Upper range minimum ≥ 0.312 .

If you initially select to edit 16 channels, but change your mind, you can enter an Upper range of 10 before the 16th channel. This will end the channel edit and enable the OK button. You can then keep the current settings with less than 16 channels defined.

If you have enabled the use of an Index of refraction, the channel size range may be affected. The corrected range is displayed as shown below.

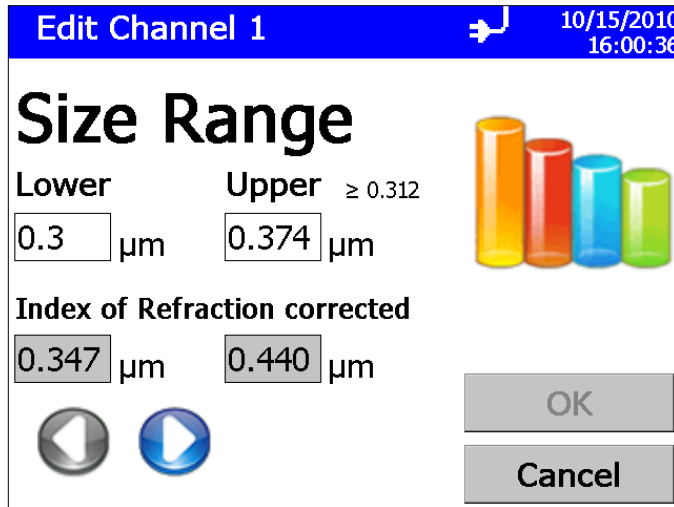

Figure 4-24
Index of Refraction Corrected Screen

User Calibration Screen

Use this screen to set calibration parameters. Press **OK** when finished.

The screenshot shows the 'User Calibration' screen with a blue header bar containing the title, a battery icon, and the date/time '8/22/2010 19:32:46'. The main area contains three sections: 'Density' with a text box containing '1.8'; 'Index of Refraction' with an unchecked 'Enable' checkbox, a 'Real' text box with '1.1', and an 'Imaginary' text box with '0'; and 'Dead Time Correction' with a checked 'Enable' checkbox. On the right side, there is a green person icon, a 'Defaults' button, an 'OK' button, and a 'Cancel' button.

Figure 4-25
User Calibration Screen

Field	Description
Density	Enter the particle density (in g/cm ³) you want the software to use when calculating the mass concentrations. The default is 1.00. (The geometric diameter is calculated first and then the surface area and mass are derived, assuming spherical particles.) If you enter a value other than 1.0000, you are changing the y axis on the graphs; the shape of the distribution remains the same.
Index of Refraction	Check the Enable box to change the index of refraction, which changes the channel boundaries.
Dead Time Correction	Check the Enable box to allow for dead time correction, which changes the maximum concentration the instrument can detect.
For a more detailed explanation of these fields, refer to the Aerosol Instrument Manager [®] Software for Optical Particle Sizer Spectrometers Manual (part number 6004402).	

Scheduling Screen

Use this screen to set sample scheduling parameters. Press **OK** when finished. You can also set scheduling with the Aerosol Instrument Manager[®] software.

The screenshot shows the 'Scheduling' screen with the following settings:

- Enable Logging Survey Mode
- Start Date: 11/15/2010
- Start Time (h:m): 15 :14
- Sample Length (h:m:s): 00 :01 :00
- Number of Samples: 1
- Total Set Time (h:m:s): 00 :01 :00
- Repeat Interval (d:h:m): 00 :00 :01
- Number of Sets: 1
- Repeat Forever Single File

Buttons: OK, Cancel

Figure 4-26
Scheduling Screen

There are four primary modes to scheduling.

Mode 1	<p>You can run the unit without logging but follow the schedule by unchecking the “Enable Logging” and checking the “Survey Mode”. Survey mode ignores all the settings in this screen. It only enables the unit the run continuously updating the display once a second without saving any data. The pump will run as long as you stop the test. A sample setup is shown below:</p>
---------------	--

The screenshot shows the 'Scheduling' screen with the following settings:

- Enable Logging Survey Mode
- Start Date: 11/23/2010
- Start Time (h:m): 02 :05
- Sample Length (h:m:s): 00 :00 :01
- Number of Samples: 1
- Total Set Time (h:m:s): 00 :00 :01
- Repeat Interval (d:h:m): 00 :00 :01
- Number of Sets: 1
- Repeat Forever Single File

Buttons: OK, Cancel

Mode 2

You can “Enable Logging” and uncheck “Survey Mode” run the unit as specified in the scheduling screen. Under these conditions, one data point is collected at the end of each sample. There are multiple ways to generate files which will be discussed in detail below. After the scheduled tests are completed, the pump will turn off but the unit will remain turned ON.

Scheduling 11/23/2010 02:18:57 AM

Enable Logging Survey Mode

Start Date: 11/23/2010

Start Time (h:m): 02 :05

Sample Length: (h:m:s) 00 :00 :01

Number of Samples: 30000

Total Set Time: (h:m:s) 00 :00 :01

Repeat Interval: (d:h:m) 00 :00 :01

Number of Sets: 1

Repeat Forever Single File

OK Cancel

Mode 3

You can “Enable Logging” and check “Survey Mode” to continuously run the unit until you stop the test. Under these conditions, one data point is collected at the end of the sample.

Scheduling 11/23/2010 02:06:15 AM

Enable Logging Survey Mode

Start Date: 11/23/2010

Start Time (h:m): 02 :05

Sample Length: (h:m:s) 00 :00 :01

Number of Samples: 1

Total Set Time: (h:m:s) 00 :00 :01

Repeat Interval: (d:h:m) 00 :00 :01

Number of Sets: 1

Repeat Forever Single File

OK Cancel

Mode 4

You can also run the unit as per the schedule but not log data by checking the “Repeat Forever”. This mode is to mimic Aerosol Instrument Manager® software where the unit can be scheduled to run at any user defined schedule but the instrument is not logging data, instead an external program could log data without having to send other commands to start/stop the unit.

Scheduling 11/23/2010 02:55:06 AM

Enable Logging Survey Mode

Start Date: 11/23/2010

Start Time (h:m): 02 :05

Sample Length: (h:m:s) 00 :00 :01

Number of Samples: 30000

Total Set Time: (h:m:s) 00 :00 :01

Repeat Interval: (d:h:m) 00 :00 :01

Number of Sets: 1

Repeat Forever Single File

OK Cancel

Scheduling Details

Scheduling Screen also enables and Disables logging. If Repeat Forever is enabled, the logging is disabled. When the instrument is set to log by checking the Enable Logging, each test has sample length and number of samples within each test. So, to sample every minute for 10 minutes and log data to a single file, set sample length to 1 minute and number samples to 10. Alternatively, Sample Length can also be set to 10 minutes and Number of Samples to 1 and obtain one single file. The key difference between the two tests is that in the case where the sample length was 1 minute, you would get time resolved data once a minute for next 10 minutes. On the other hand, setting the sample length to 10 minutes will provide you with one data file with cumulative counts over that 10 minutes. If the size distribution changed during sampling, you would not notice it in a sample with 10 minutes but do so in a test where the sample length was 1 minute but repeated 10 times. A typical setup for 10 1-minute samples is shown in Figure 4-27.

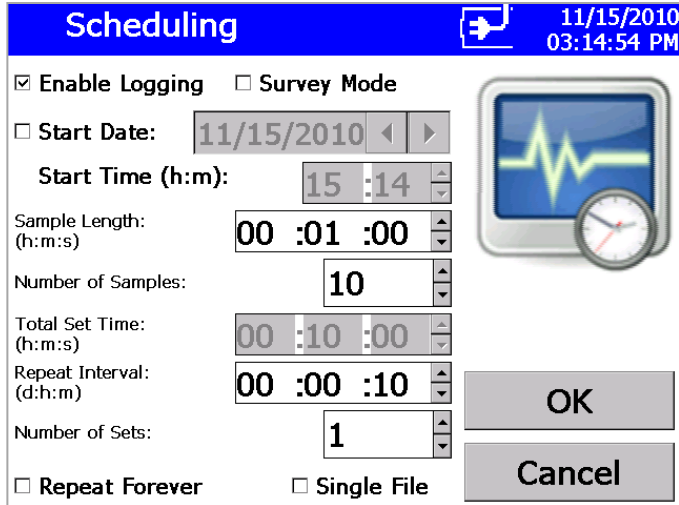

Figure 4-27
Scheduling Screen—Sample Length: 00:01:00, Number of Samples: 10, Repeat Interval: 00:00:10, Number of Sets: 1

If you desire to save data into different files, you can set the sample length to 1 minute, number of samples to 1, repeat interval to 1 minute and set the number of sets to 10 as shown below. Repeat interval determines if there is any sample delay between two consecutive samples. If we want no sample delays, the repeat interval has to set equal to Sample Length \times Number of Samples (in this case it would be 1 minute). Note that the Repeat interval is in (d:h:m) format while all other parameters are in (h:m:s) format. This also means that the sample delay cannot be less than one minute.

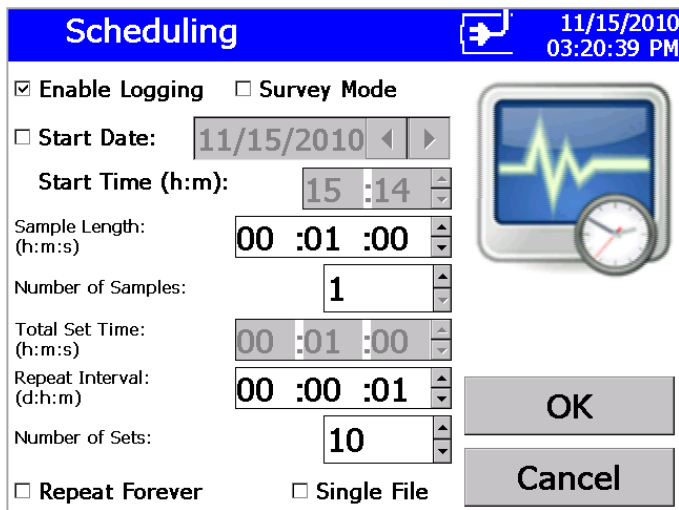

Figure 4-28
Scheduling Screen—Sample Length: 00:01:00, Number of Samples: 1, Repeat Interval: 00:00:01, Number of Sets: 10

If you would like to save all data to one file, it can also be accomplished by checking the checkbox labeled “Single File” (see Figure 4-29).

Scheduling 11/15/2010 03:22:04 PM

Enable Logging Survey Mode

Start Date: 11/15/2010

Start Time (h:m): 15 :14

Sample Length: (h:m:s) 00 :01 :00

Number of Samples: 1

Total Set Time: (h:m:s) 00 :01 :00

Repeat Interval: (d:h:m) 00 :00 :01

Number of Sets: 10

Repeat Forever Single File

OK Cancel

Figure 4-29
Single File Setup Screen

In order to introduce sample delay between tests, you can use the repeat interval to create a sample delay between samples. Suppose you want to log data every other minute. You would set the sample length to 1 minute, number of samples to 1, Repeat Interval to 2 minutes (instead of 1 minute for continuous samples), and Number of Sets to 10 as before. If you also want the data to be logged to a single file, check the checkbox labeled “Single File” (see Figure 4-30).

Scheduling 11/15/2010 03:32:12 PM

Enable Logging Survey Mode

Start Date: 11/15/2010

Start Time (h:m): 15 :32

Sample Length: (h:m:s) 00 :01 :00

Number of Samples: 1

Total Set Time: (h:m:s) 00 :01 :00

Repeat Interval: (d:h:m) 00 :00 :02

Number of Sets: 10

Repeat Forever Single File

OK Cancel

Figure 4-30
Logging Data to a Single File

Note that the total sample length cannot be set greater than 24 hours. This includes the number of samples as well in this limitation. In other words, you cannot set the sample time to 12 hours and set the number of samples to more than 2 ($12 \times 2 = 24$ hours). To accomplish sampling for more than 24 hours, you need to split that test in to different sets. You can then set the sample length to say 12 hours and set number of samples to 1 but can set the number of sets to any length. For example, assuming that you would like to get one reading once a day, you would want to repeat this test for 10 days. The setup parameters would be, Sample Length of 24 hours, number of samples of 1 (cannot be more than 1 since the total sample length is limited to 24 hours), repeat interval would be 1 day (for continuous sampling) and Number of Sets would be 10, representing 10 days of sampling. The setup screen would look like the one shown in Figure 4-31.

The screenshot shows a 'Scheduling' dialog box with the following fields and options:

- Title Bar:** Scheduling, 11/15/2010, 03:34:12 PM
- Enable Logging Survey Mode
- Start Date: 11/15/2010
- Start Time (h:m): 15 :32
- Sample Length: (h:m:s) 24 :00 :00
- Number of Samples: 1
- Total Set Time: (h:m:s) 24 :00 :00
- Repeat Interval: (d:h:m) 01 :00 :00
- Number of Sets: 10
- Repeat Forever Single File
- Buttons: OK, Cancel
- Icon: A monitor displaying a green ECG waveform and a clock.

Figure 4-31
Scheduling Screen—Sample Length: 24:00:00, Number of Samples: 1, Repeat Interval: 01:00:00, Number of Sets: 10

Suppose you would like better resolution over the sampling period and decide to obtain all the data into a single file. In that case, you can change the Sample Length to 1 hour, Number Samples would be 24 (1 hour samples for 1 full day), repeat interval would still be 1 day and Number of Sets would still be 10 representing 10 days as shown in Figure 4-32.

Scheduling 11/15/2010 03:54:36 PM

Enable Logging Survey Mode

Start Date: 11/15/2010

Start Time (h:m): 15 :54

Sample Length: (h:m:s) 01 :00 :00

Number of Samples: 24

Total Set Time: (h:m:s) 24 :00 :00

Repeat Interval: (d:h:m) 01 :00 :00

Number of Sets: 10

Repeat Forever Single File

OK Cancel

Figure 4-32
Scheduling Screen—Sample Length: 01:00:00, Number of Samples: 24, Repeat Interval: 01:00:00, Number of Sets: 10

If you desire sample delays in your sampling schedule, you can change the repeat interval such that the repeat interval is equal to the Sample Length × Number of Samples + Sample Delay. For example, assume you would like 1 hour samples every day for 8 hours and no data for the next 16 hours over 5 days (1 work week), the scheduling would require the Sample Length to be set to 1 hour, Number of Samples would be set to 8 hours, Repeat Interval would be set to 1 day and Number of Sets would be set to 5 for a work week’s worth of sampling. See setup screen in Figure 4-33.

Scheduling 11/15/2010 04:48:37 PM

Enable Logging Survey Mode

Start Date: 11/15/2010

Start Time (h:m): 16 :48

Sample Length: (h:m:s) 01 :00 :00

Number of Samples: 8

Total Set Time: (h:m:s) 08 :00 :00

Repeat Interval: (d:h:m) 01 :00 :00

Number of Sets: 5

Repeat Forever Single File

OK Cancel

Figure 4-33
Scheduling Screen—Sample Length: 01:00:00, Number of Samples: 8, Repeat Interval: 01:00:00, Number of Sets: 5

Hence, a combination of Sample Length, Number of Samples and Number of Sets should meet all sampling requirements. If you would like all data to be saved to a single file, the checkbox labeled “Single File” should be checked. If not, a test file is created for each set of data. However, all samples within a data set are saved to the same file. Note that the maximum number of data points that can be stored is 30,000 points. The built-in memory allows logging up to 30,000 1-second samples (or 500 minutes or approximately 8 hours of continuous 1-second samples). To set up a unit to log data every second for 30,000 samples adopt the details shown below.

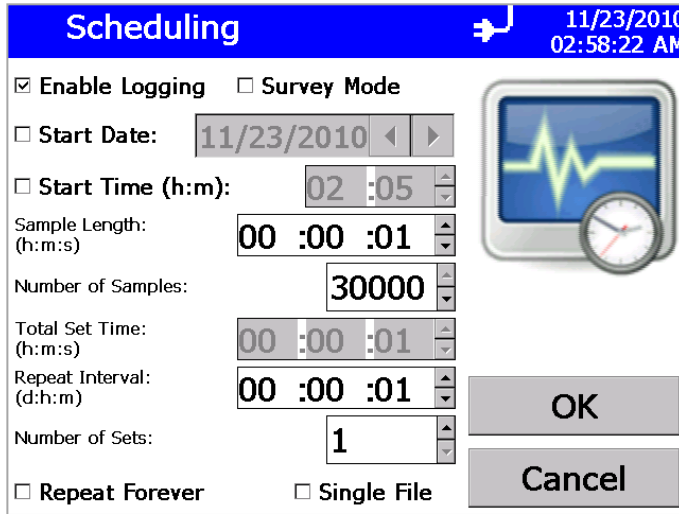

Figure 4-34
Scheduling Screen: Sample Length: 00:00:01, Number of Samples: 30,000, Repeat Interval: 00:00:01, Number of Sets: 1

Field	Description
Enable Logging	Check this box to enable logging. If you do not check this box, the sample data you collect is NOT saved to the instrument. Note: You may not Enable Logging and Repeat Forever at the same time.
Survey Mode	Check this box to use survey mode. If this box is checked, the instrument runs a real time, continuous active sample. If Enable Logging is also used then a data set with 1 sample will be logged at the time the survey is stopped.
Start Date	Check this box to set the date and time to start sampling. Use the arrows or the on-screen keyboard to set the date and time.
Sample Length	Enter the length of time data will be collected for each sample.
Number of Samples	Enter the total number of samples to be collected.

Field	Description
Total Set Time	<p>Displays the total time during which samples will be collected.</p> <p>Note: Total set time may not exceed 24 hours.</p>
Repeat Interval:	<p>Enter how often a set of samples should be repeated. This value must be greater than or equal to the Total Set Time.</p>
Number of Sets	<p>Enter the number of times a set of samples should be repeated.</p>
Repeat Forever	<p>Check this box to repeat sampling indefinitely. This mode can be used when external programs (such as Labview or HyperTerminal) are being used to collect data.</p> <p>Note: You may not Enable Logging and Repeat Forever at the same time.</p>
Single File	<p>Check this box to save all data to a single data set. If this box is not checked, data may be saved to multiple data sets.</p>

Alarms Screen

Use this screen to set the alarm threshold. Press **OK** when finished.

The screenshot shows the 'Alarms' screen with a blue header bar. The header contains the title 'Alarms', a battery status icon, and the date and time '8/22/2010 19:42:16'. Below the header, the 'Type' section has three checkboxes: 'Visible' (checked), 'Audible' (checked), and 'Relay' (unchecked). To the right of these checkboxes is a red bell icon. Below the 'Type' section, the 'Units' are set to '#/cm3' in a dropdown menu. The 'Threshold' is set to '2500' in a text input field. On the right side, there are three buttons: 'Defaults', 'OK', and 'Cancel'.

Figure 4-35
Alarms Screen

Field	Description
Type	When the total value of the units selected exceeds the threshold value you set, the type of alarm you select is activated. If you check Visible, the alarming data is highlighted on the Main tab. If you check Audible, an alarm sounds. If you check Relay, a signal is sent to the attached device. See Wiring the Alarm . You can select all alarms if desired. The visible alarm is automatically enabled if audible or relay is selected.
Units	Select the threshold units. Number of particles per cubic centimeter ($\#/cm^3$) or micrograms per cubic meter ($\mu g/m^3$).
Threshold	Enter the threshold value, 0.001 through 10000 ($\#/cm^3$) or 200000000 ($\mu g/m^3$), that will trigger the alarm. The alarm will remain until the value drops 5% below the threshold value.

To clear an audible alarm, click the alarm icon  on the Main tab.

Protocol Screen

Use this screen to load, view, delete, and save protocols. A protocol is a group of settings that you use often. Save these settings as protocols so you don't have to reset individual settings. There are six preset protocols shipped with the instrument that cannot be deleted. You may save up to 10 additional protocols in the unit.

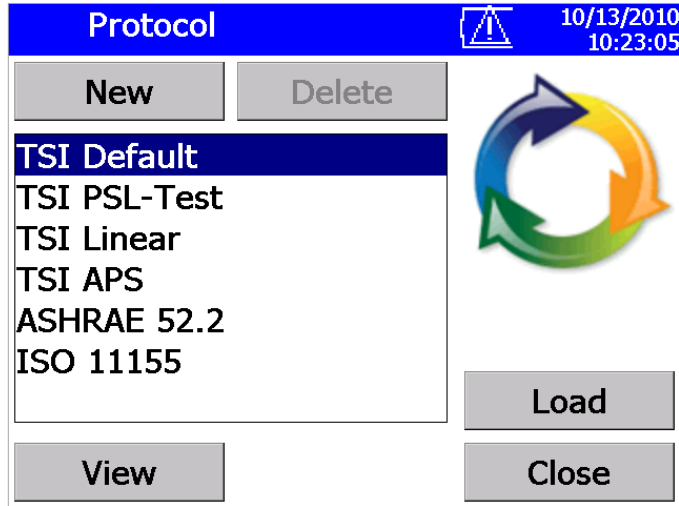

Figure 4-36
Protocol Screen

Field	Description
New	Select New , to save the settings that are currently set. When you select New , a window opens that lets you enter a name for the protocol you want to save. Enter a name and press OK . Note: The name is restricted to 12 characters. The name may not consist of '\', '/', ' ', '*', '?', '"', '!', '<' or '>' characters.
Delete	Highlight the protocol you want to delete and press Delete . The protocol is deleted. (Preset protocols shipped with the instrument cannot be deleted.)
View	Highlight the protocol you want to view and press View . See below for an example of the information/setting saved in the protocol.
Load	Highlight the protocol you want to load and press Load . The settings for that protocol are loaded for the instrument to use. The protocol name will become the base part of the current data set name.

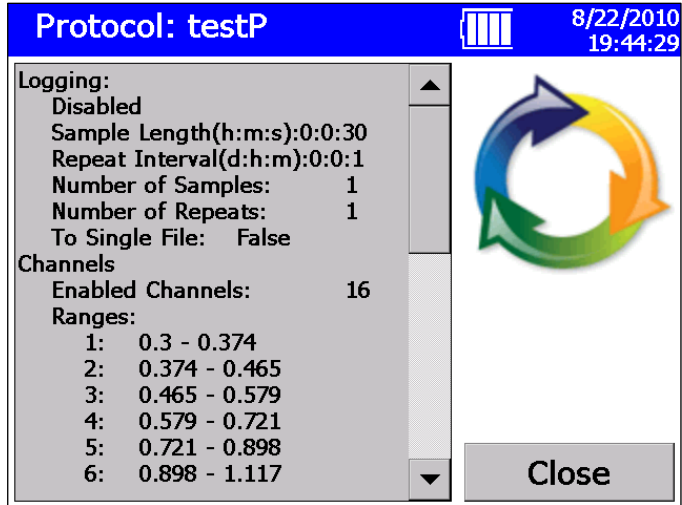

Figure 4-37
Protocol testP Screen

Data Tab

The Data tab lets you save, delete, or view data that has been collected.

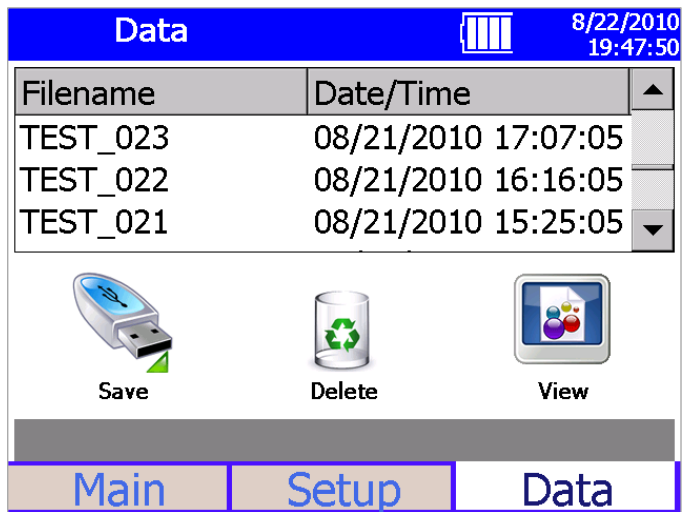

Figure 4-38
Data Tab Screen

Save Data

Use this screen to save a single data set to a thumb drive.

1. Insert a USB flash drive into the OPS.
2. Highlight the filename for the data you want to save.
3. Press **Save**.
4. Verify that you want to save this file by pressing **Yes**.
5. A message appears to indicate the progress of the save. Refer to [Appendix B](#) for a description of the data saved in the .csv files.

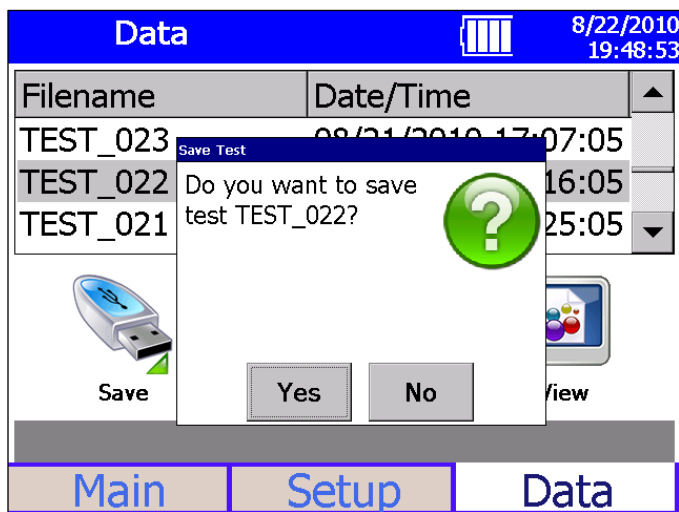

Figure 4-39
Data Tab – Save Data Screen

Delete Data

Use this screen to delete data from the device.

1. Highlight the data set you want to delete.
2. Press **Delete**.
3. Verify that you want to delete this data set by pressing **Yes**.
4. A message appears to indicate the progress of the save.

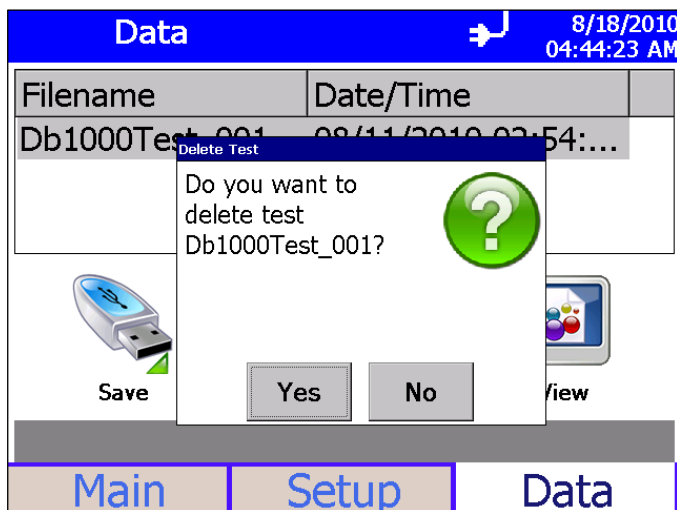

Figure 4-40
Data Tab – Delete Data Screen

View Data

Use this screen to view data files in the OPS.

1. Highlight the data set you want to view.
2. Press **View**.
3. The first sample in the dataset is displayed.
4. Refer to the Main tab for descriptions of fields and buttons.
5. Use the arrow buttons to advance through the data sample by sample.
6. Press **Back** when done.

View TEST_019				10/13/2010 10:27:46	
Ch:	Size (µm)	#/cm3	µg/m3	Totals	
1:	0.300 - 0.374	83.78	1.699	67941	#
2:	0.374 - 0.465	18.92	0.740	11.52	#/cm3
3:	0.465 - 0.579	7.445	0.561	5.444	µg/m3
4:	0.579 - 0.721	3.107	0.452		
5:	0.721 - 0.897	2.321	0.651		
6:	0.897 - 1.117	1.830	0.990		
7:	1.117 - 1.391	0.559	0.584		
8:	1.391 - 1.732	0.755	1.524		
9:	1.732 - 2.156	0.819	3.186		
10:	2.156 - 2.685	0.466	3.504		
Sample 1 of 1			10/13/2010 09:44:08		
 Back					

Figure 4-41
View Data Screen

(This page intentionally left blank)

CHAPTER 5

Theory of Operation

The Model 3330 Optical Particle Sizer (OPS) operates on the principle of single particle counting.

The OPS uses a laser and a detector to detect particles passing through a sensing volume illuminated by the laser. The flow rate being sampled in to the instrument is 1.0 L/min. Additionally, there is 1.0 L/min of sheath flow supplied from the exhaust of the pump. Hence, sheath flow is internally circulated from the pump.

Sheath flow keeps the particles well focused across the laser light and also prevents the optics from getting contaminated. Beam shaping optics focus the laser light and convert that to a fine sheath with maximum intensity across the particle beam. The viewing volume is created by the intersection of the laser sheath and the particle flow. Flow control is established by measuring the pressure drop across two orifices, one in the sample flow and another in the sheath flow. Both flows are maintained at 1.0 L/min. The sample flow is controlled to 1.0 L/min and is user-adjustable. However, sheath flow is only monitored and cannot be controlled.

As shown in Figure 5-1, particles pass through the beam and light scattered by the particles is picked up by an elliptical mirror and focused onto the photodetector. Excess laser light is focused on to the light trap or beam dump.

All signal processing is performed in the electronics. The thresholds are set such that the instrument always counts 50% of 0.3 μm particles. Particle pulses are counted individually and binned in to the 16 channels (number of channels can be varied) based on their pulse heights. The maximum particle size that can be counted is 10 μm . Particles above 10 μm will be counted but not sized.

Particles exiting the chamber are trapped by a gravimetric filter. The filter is removable and the sampled aerosol can be used for chemical analysis after the sample has been taken. The pump is protected from the particles by the cassette filter. Downstream of the pump is a coarse filter and a HEPA filter.

Sample Flow Path

The sample flow path in the OPS Model 3330 Figure 5-1. Aerosol is drawn into the inlet and is immediately surrounded by sheath flow that is provided from the exhaust of the pump.

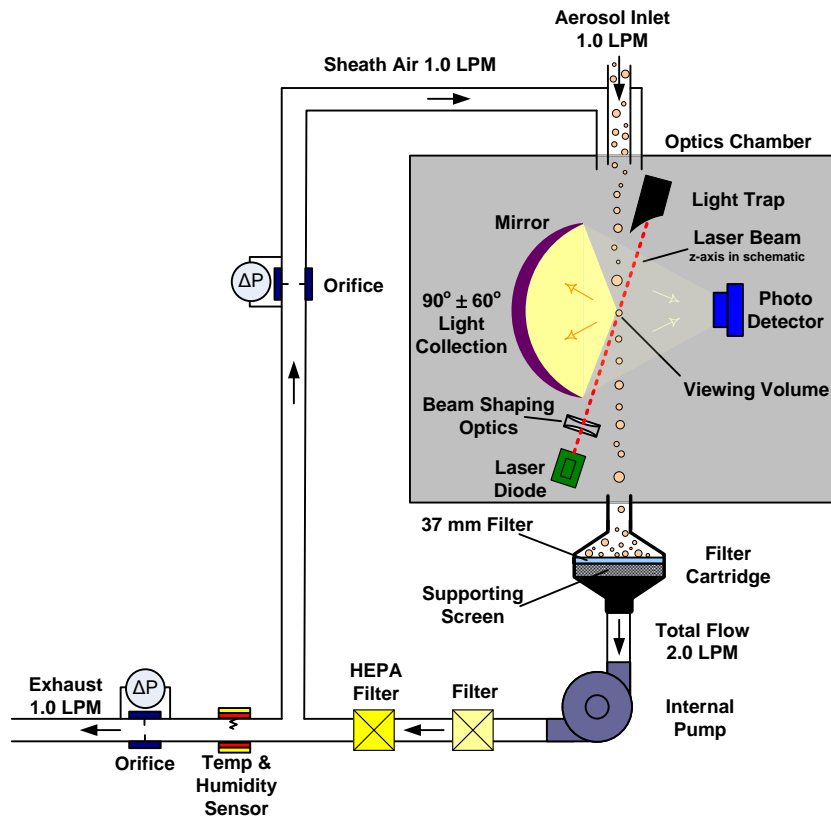

Figure 5-1
Sample Flow Path in the OPS Model 3330

The sheath flow is filtered and monitored by the pump. The sheath flow is monitored by measuring the pressure drop through an orifice. This pressure drop is converted by the firmware to a volumetric flow with compensation for absolute atmospheric pressure.



C a u t i o n

If you are attaching the inlet of the OPS to a particle generator or test duct that has positive pressure, you should have the OPS pump turned on before connecting to the generator or duct. This can be accomplished by starting a sample prior to attaching tubing to the OPS inlet nozzle or by using the "Keep Pump On" mode. The OPS is protected against contamination using sheath flow technology. If particles are introduced into the instrument without first having the pump running (by starting a sample), then the optics chamber is at risk of becoming contaminated, and/or the unit may not be able to start the measurement because of high background scattering light. Similarly, make sure you disconnect the inlet from the particle generator while the OPS pump is still running.

N o t e

In order to avoid the problem described above, the OPS pump can be configured to run continuously. In "Keep Pump On" mode, the OPS pump is always running any time the unit is turned ON. Use discretion when enabling "Keep Pump On" mode as the pump life will be reduced if the OPS pump is left running all the time. For applications where the unit is connected to a test duct, TSI recommends that "Keep Pump On" mode be enabled. Further details regarding "Keep Pump On" mode can be found in the manual under **Setup | System | Flow Calibration**. This also affects the diagnostics screen under **Setup | Device | Diagnostics**.

After passing through the orifice, the sheath flow is directed to the optics chamber where it surrounds the sample flow. There is no acceleration of the flow or the particles. The sheath flow confines the sample particles to the center stream keeping the optics clean. There is no other purpose for the sheath flow than keeping the particles in the center of the viewing volume nozzle.

After measurement, the particle stream exits the optics chamber, drawn by the pump. Sample flow is filtered before and after each of the pump. The filter upstream of the pump protects the pump from contamination. The filters downstream of the pump remove any remaining particles from the air stream and particles that can be shed from the pump.

Optics Path

The first component in the optics path, see Figure 5-1, is the laser diode. Light coming from the laser is polarized vertically. It passes through a collimating lens and then a cylindrical lens to make the beam like a thin sheath which is focused just below the centerline of the inlet nozzle.

In addition, the beam is cleaned by passing it through two apertures before entering the optics chamber. After passing through the sampling nozzle, the laser is stopped by the beam dump (beam stop). The light scattered by the particles is captured by an elliptical mirror and focused onto a photodiode.

Concentration Calculation

The OPS measures particle concentration by counting individual pulses from the photodetector. This works well when particle concentrations are low, but when particle concentrations are high, pulses start to overlap each other. Because of this, particle concentrations based solely on the number of pulses underestimates the number of particles entering the viewing volume.

When a particle is detected entering the optical viewing volume, no other particles can be counted until that particle leaves the viewing volume. As the particle concentrations increase, the amount of time blocked by the presence of particles becomes significant. If the particle concentration is computed using elapsed time, the value will be under reported.

The actual sample time needs to be corrected for this blocked or dead-time. To adjust for this effect, the OPS measures the dead-time resulting from the presence of particles in the viewing volume and subtracts it from the sample time. This sample live-time value is used in place of the sample time for the concentration calculations, as shown in the equation below. At very high concentrations, the dead-time value grows and the adjustment becomes large. Single particle events may not even be detected since particles are nearly continually in the measurement viewing volume and the accuracy of the live-time measurement begins to diminish.

The High Concentration warning will flag when the concentration error exceeds 10%. The threshold of this warning depends whether the dead time correction is turned on and off. The threshold is set at 1000 #/cm³ (total concentration) when dead time correction is disabled. With dead time correction enable, the threshold is set at 3000 #/cm³ (total concentration). By default, the dead time correction is enabled and can be turned off at the instrument or in the Aerosol Instrument Manager[®] software program.

$$C_i = \frac{N_i}{Q \times (t_s - DTC \times t_d)}$$

where,

- C_i = concentration at size channel i
- N_i = number count in #/cm³ at size channel i
- Q = sample flow rate, 16.67 cm³/s
- t_s = sample time in second
- t_d = dead time in second
- DTC = dead time correction factor

When measuring polydisperse aerosol, the dead time correction may have additional error because the particle pulse widths increase with particle sizes so the amount of dead time measured by the counter is the “average” dead time caused by various pulses. This average dead time is then applied to all size channels. It is estimated that the concentration error caused by the non-uniform pulse widths is no more than 15% of total concentration.

Notes: Concentrations (including normalized concentrations) can be corrected with dead time correction factor. Count data (raw counts) are **never** corrected for dead time.

The Log File data (what can be downloaded from the OPS with a flash drive) is in count form and is not corrected for dead time. If the data is imported into Aerosol Instrument Manager[®] software the dead time correction can be applied to all forms of concentration data.

(This page intentionally left blank)

CHAPTER 6

Maintenance

Most components of the Optical Particle Sizer (OPS) spectrometer are solid state and require no maintenance. This section provides information about the maintenance procedures that are required and includes a suggested maintenance schedule. TSI recommends that you return your OPS to the factory for annual calibration.



WARNING

There are no user-serviceable parts inside this instrument besides the inlet nozzle and the filters that are accessible through the back access door. The instrument should only be opened by TSI or a TSI approved service technician.

Maintenance Schedule

Table 6–1 lists the factory recommended maintenance schedule. Use the schedule as a guideline only.

The conditions under which the instrument is used will greatly affect its need for maintenance. If the instrument is used to sample unusually dirty environments, the times between maintenance should be shortened. Likewise, if the instrument is used in clean environments, the times between maintenance can be safely extended.

Items are scheduled according to how much aerosol is drawn through the instrument. For example, cleaning the inlet sample tube is recommended after a month of running 0.5 μm PSL at the rate of 1500 p/cc continuously. This recommendation should be pro-rated according to how the instrument is used and what particle sizes are run through the instrument. For example, if you run Arizona Road Dust (density of 2.65 g/cc) at 1500 p/cc continuously, the nozzle needs to be cleaned once every 11 days.

Table 6-1
Recommended Maintenance Schedule

Item	Frequency
Clean inlet	Once a month at 1500 p/cc if operated continuously
Replace internal filters	Once a month at 1500 p/cc if operated continuously indicator.
Return to factory for cleaning and calibration.	Annually

Cleaning the Inlet

The inlet should be cleaned based on the schedule in Table 6-1.

1. Turn the Model 3330 OPS off.
2. Unscrew the inlet nozzle from the instrument (Figure 6-1).



Figure 6-1
Unscrew Inlet Nozzle

3. Clean the inlet port. A cotton swab can be used to clean the outside of the inlet port. The swabs can be dampened with water or a light solvent (e.g., isopropanol). The inside of the sample tube can be cleaned using a small brush, along with a light solvent. Dry the tube by blowing it out with compressed air, or let it air-dry thoroughly.

Note

Be careful **not** to blow particles into the inlet port.



Figure 6-2
Do **NOT** Blow into the Instrument.

4. Screw (hand-tighten) the inlet back into the instrument.

Replacing the Internal Filters

The internal filters should be replaced based on the schedule in Table 6–1 or when the filter indicator on the main screen changes to red.

To replace the filters, proceed as follows:



W A R N I N G

Make sure power is switched off and power cord is disconnected to avoid any exposure to hazardous laser radiation.



C a u t i o n

The electronic circuits within this instrument are susceptible to electrostatic discharge (ESD) damage. Use ESD precautions to avoid damage.

- Use only a table top with a grounded conducting surface
- Wear a grounded, static-discharging wrist strap

1. Turn the instrument off.
2. Open the filter access door on the back of the instrument.
3. Use the enclosed filter removal tool to unscrew the filter cap.
4. Pull out the single cylindrical filter from filter well. If filter well is visibly dirty, blow out with compressed air.
5. Remove old filters from the instrument.

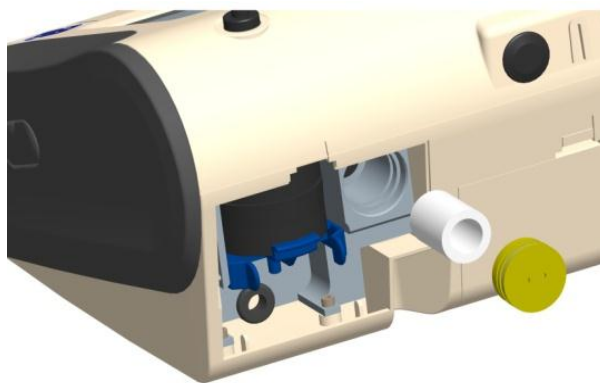

Figure 6-3
Pull out Single Cylindrical Filter from Filter Well

6. Put a new filter back into filter well and screw filter cap back into place.
7. Open blue retention clip by pinching ends inward and pushing down.

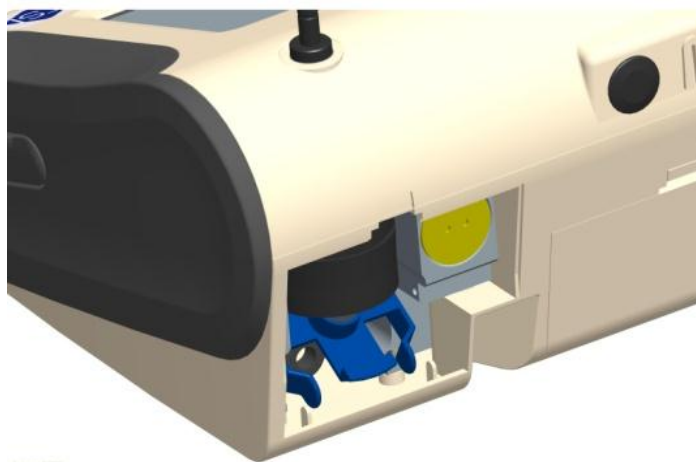

Figure 6-4
Open Blue Retention Clip

8. Remove 37-mm filter cassette by pulling downward and outward.

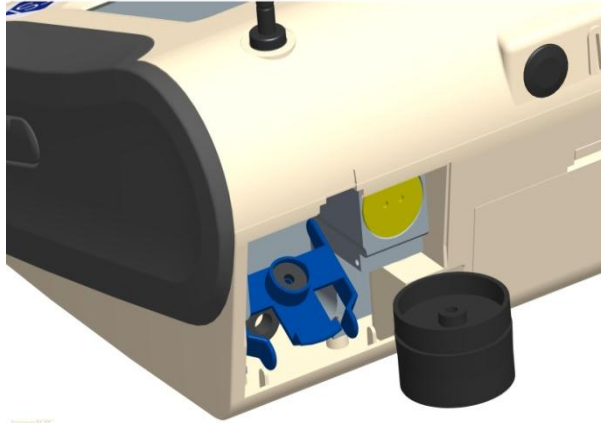

Figure 6-5
Remove 37-mm Filter Cassette

9. Open filter cassette using supplied tool.

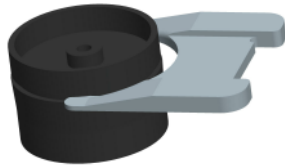

Figure 6-6
Open Filter using Supplied Tool

10. Remove 37-mm filter (if present) and screen mesh from filter cassette. The screen can be blown out using compressed air, blowing in the reverse direction to remove captured particulate. Note that the mesh screen must be used all the time to protect the pump from getting exposed to sampled aerosol.
11. Replace mesh screen in filter cassette, place filter on screen (if desired) and press halves together. Ensure that the filter holder has been fully closed. The filter tool PN 7001303 can be used to ensure the filter holder is fully closed.



Figure 6-7
Checking Filter Holder to confirm that it is Fully Closed

12. Place filter cassette back into position and close blue retaining clip. Make sure retaining clip snaps back into place.

N o t e

Replacement cylindrical filters (P/N 1130006) were shipped with the new instrument. Additional 37-mm Filter Cassettes (with mesh screen) can be ordered from TSI under PN 1130002.

TSI **does not** supply any filter media for the filter cassette. Any commercially available 37-mm filter media may be used with the instruments to collect gravimetric reference samples. When filter media is not being used, make sure the mesh screen is always installed in the 37-mm filter cassette. The mesh screen can be removed if filter media is installed. This protects the pump from any large debris that may get in to the inlet of the pump in absence of the mesh screen or the filter media.

13. It is important to reset the instruments filter counter after replacing filters. Resetting the counter clears the filter error condition shown on the main screen. Reset the counters using the following instructions:
 - a. Turn on the instrument.
 - b. Navigate to the Information screen by pressing the **Setup** tab and the Device and Information buttons.
 - c. Click the **Reset Filter Date** button to set the filter change date to the current date and reset the filter load value.

Storage Precautions

When storing the instrument for more than 30 days, the batteries should be charged and removed. This prevents damage due to battery leakage.

This instrument must be stored in a location where the temperature remains between -4 and 140°F (-20 and 60°C).

Calibrating the OPS Spectrometer

Calibrating the OPS spectrometer is a complex procedure. The calibration process requires special equipment and tools. Therefore, it is recommended you return the instrument to the factory for calibration.

APPENDIX A

Model 3330

Specifications

The following specifications list the most important features of the Model 3330. Specifications are subject to change without notice.

Table A-1
Model 3330 Optical Particle Sizer Specifications

Particle Size Range	0.3 to 10 µm
Size Channels	Up to 16, user adjustable size channels with the ability to save size channel settings.
Size Channel Configurations	Boundaries for all size channels except the first and the last channel can be changed. This enables you to program custom size channels.
Display	Graphical or tabular size distribution displayed with count, mass, linear or log normalizations, totals (count, number and mass concentrations). All displayed
Size Resolution	5% @ 0.5 µm per ISO 21501-1
Zero Count	<1 count per 1 minute
Flow Rate	Sample Flow of 1.0 L/min Sheath Flow of 1.0 L/min
Flow Accuracy	Sample Flow of 1.0 L/min ±5% accuracy internal flow controlled
Operational Temp	32 to 113°F (0 to 45°C)
Storage Temp	-4 to 140°F (-20 to 60°C)
Operational Humidity	0 to 95% RH, non-condensing
Time Constant	1 second
Data Logging	Internal on-board memory
Log Interval	User adjustable, 1 second to 24 hours
Physical Size (HWD)	5.3 x 8.5 x 8.8 in. (13.5 x 21.6 x 22.4 cm)
Weight	Base unit (without battery) 4.35 lb (~2 kg), 5.3 lb (~2.4 kg) – with 1 battery 6.25 lb (~2.8 kg) – with 2 batteries
Communications	USB (Host and Device) and Ethernet. Stored data accessible using flash memory drive
Power–AC (AC Adapter)	100 – 240 VAC 50-60 Hz Universal line cord with multiple adapter plugs
Power–DC	24V DC at 2.5A
Analog Out	User selectable output, 0 to 5V @ 15 mA or 4 to 20 mA with maximum impedance of 250 Ohms. User selectable scaling range

Table A-1
Model 3330 Optical Particle Sizer Specifications

Alarm Out	Relay with 30 VDC @ 2A maximum rating or audible buzzer
Screen	5.7 in. VGA color touchscreen with graphical display
Gravimetric Sampling	Removable 37-mm cartridge
CE Rating	Immunity EN61236-1:2006 Emissions EN61236-1:2006 Safety CAN/CSA C22.2 No 61010-1  Indicates the product has been tested to CAN/CSA C22.2 No. 61010-1 Second Edition, including Amendment 1
Light Source	Long life laser diode
Sampling Modes	Manual, automatic,
Flow Source	Internal pump
Positive Pressure	When attaching the instrument to a test setup, the inlet pressure must be <math><3''\text{H}_2\text{O}</math> higher than the outlet. The unit will not be able to control flow with higher delta pressures and will show a flow alarm.
Status Indicators	Low battery, flow, laser, alarm
Software	Supplied with Aerosol Instrument Manager [®] software
Unit ID	Configurable IP address
Calibration	NIST traceable using TSI calibration system
Calibration Frequency	Recommended minimum of once per year
Warranty	One year, extended warranties and service agreements available
Included Accessories	Printed operation manual, power supply, battery, purge filter, USB cable, carrying case, and Aerosol Instrument Manager [®] software and printed software manual.
Optional Accessories	Additional battery, dual port external battery charger, aerosol diluters and environmental enclosure

APPENDIX B

CSV File

When you create a new file for the first time, the Optical Particle Sizer creates a folder on the thumb drive using the device serial number as the folder name, for example “3330103511.” All data files created with this device are stored in this folder.

The file name includes the test start date, start time, and protocol name and number, for example `YYYY_MM_DD-HH-MM-NAME_###.csv`

The illustration on the next two pages provides the format of the .csv file.

Instrument Name	Optical Particle Sizer		NOTE:	The unit creates a new folder on the thumbdrive with the units serial number as the name of the folder								
Model Number	3330											
Serial Number	14			The file name is the Test start date, time, and protocol name and number								
Firmware Version	1			YYYY_MM_DD-HH-MM-NAME_###.csv								
Calibration Date	10/11/2010											
Protocol Name_Number	TEST_022	if "TEST" in front than not using a saved protocol										
Test Start Time	7:18:35											
Test Start Date	10/15/2010											
Test Length [D:H:M:S]	0:0:2:50											
Sample Interval [H:M:S]	0:00:10											
Number Channels Enabled	16											
Bin 1 Cut Point (um)	0.3											
Bin 2 Cut Point (um)	0.374											
Bin 3 Cut Point (um)	0.465											
Bin 4 Cut Point (um)	0.579											
Bin 5 Cut Point (um)	0.721											
Bin 6 Cut Point (um)	0.897											
Bin 7 Cut Point (um)	1.117											
Bin 8 Cut Point (um)	1.391											
Bin 9 Cut Point (um)	1.732											
Bin 10 Cut Point (um)	2.156											
Bin 11 Cut Point (um)	2.685											
Bin 12 Cut Point (um)	3.343											
Bin 13 Cut Point (um)	4.162											
Bin 14 Cut Point (um)	5.182											
Bin 15 Cut Point (um)	6.451											
Bin 16 Cut Point (um)	8.031											
Bin 17 Cut Point (um)	10			Alarm set point								
Alarm	0.000 #/cm3											
Density	1	Particle Density used to calculate mass										
Refractive Index	0.000+0.000j	Zero's indicate RI was not used										
Shape Correction Factor	0	Zero's indicate Shape Correction Factor was not used										
FlowCal	1											
DeadTime Correction Factor	1	Used in Deadtime correction calculation										
Errors				Errors will be ';' seperated and could be: "Laser Error"; "Laser Error"; "Filter Warning"; "Coincidence Error"; "Test Stopped from Flow Block"								
Number of Samples	15											
Elapsed Time [s]	Bin 1	Bin 2	Bin 3	Bin 4	Bin 5	Bin 6	Bin 7	Bin 8	Bin 9	Bin 10	Bin 11	...
10	686	114	99	10	10	4	0	4	4	2	1	...
20	745	173	57	14	26	5	0	1	4	3	1	...
30	722	157	63	11	21	3	2	2	2	1	2	...
40	672	151	62	16	23	3	1	6	5	1	0	...
50	777	137	54	15	15	1	2	0	6	3	1	...
70	721	126	51	13	12	3	2	3	1	2	1	...
80	743	144	49	14	14	2	2	1	3	3	1	...
90	724	146	43	14	13	4	1	4	2	2	1	...
100	652	147	53	16	19	2	1	6	3	2	0	...
110	726	151	47	15	13	3	1	1	6	1	0	...
130	761	153	39	8	9	3	2	0	5	2	3	...
140	759	130	60	20	21	6	2	6	1	3	1	...
150	738	143	44	10	25	2	0	1	5	1	0	...
160	721	138	47	17	23	1	0	1	5	4	2	...
170	737	143	44	11	16	4	2	4	8	3	0	...
Elapsed time since start of test												

Example of csv file (continued on next page)

Sample of csv file (continued from previous page)

Bin 12	Bin 13	Bin 14	Bin 15	Bin 16	Bin 17	Deadtime (s)	Temperature (C)	Humidity (%)	Ambient Pressure (kPa)	Alarms	Errors
1	1	3	0	1	0	0.007187	32.833	16.777	98.539		
1	1	0	0	1	0	0.008128	32.874	21.456	98.548		
0	0	1	0	0	0	0.007839	32.909	21.73	98.545		
1	2	1	0	1	0	0.007605	32.948	21.911	98.542		
2	0	0	0	0	0	0.008065	32.989	22.047	98.542		
2	0	0	0	1	0	0.00755	33.048	22.268	98.539		
1	0	0	1	1	0	0.00769	33.076	22.337	98.539		
0	1	1	1	2	0	0.007685	33.111	22.427	98.539		
0	0	0	0	1	0	0.007439	33.13	22.477	98.542		
1	1	0	0	1	0	0.007574	33.167	22.47	98.545		
0	0	0	0	1	0	0.00757	33.219	22.426	98.539		
0	0	1	0	0	0	0.007644	33.226	22.421	98.539		
0	0	0	0	0	0	0.007707	33.263	22.503	98.545		
1	1	0	1	0	0	0.007595	33.278	22.461	98.539		
0	2	0	0	2	0	0.007643	33.304	22.407	98.542		

Errors will be indicated for each sample where they occur

A "1" indicates that this sample was in alarm and exceeded Alarm threshold

All particles greater than last bin upper boundary

Amount of time unit was not detecting particles for each sample

(This page intentionally left blank)

APPENDIX C

Troubleshooting

This appendix lists potential problems and their solutions.

Note: *If none of the solutions provided corrects the problem, call your TSI representative for advice.*

Table C-1
Troubleshooting Symptoms and Recommendations

Symptoms	Recommendations
 <p>When this icon is displayed on the instrument it indicates there is a problem with one of the following. Click on the icon to review which error has occurred.</p>	
<p>System error. or System, scatter error</p> 	<p>This error indicates the instrument has been contaminated or has some other system-based error. Try and restart the unit and see if the error continues.</p> <p>If the error continues, follow the Cleaning the Inlet procedure (in Chapter 6) and then run the instrument for an extended period of time with the zero filter attached.</p> <p>If the above procedure does not work and the unit still has System error, you will need to remove the inlet, blow clean air into the unit, and try restarting the unit.</p> <p>You may blow compressed air into the unit only under these circumstances. Do not use high pressure compressed air. A compressed air canister can be used. Restart the instrument and if the error still continues, the instrument will need to be sent to TSI for service.</p> <p>In order to monitor how clean the chamber is getting while you clean the chamber using compressed air, go to Setup Device Diagnostics and monitor the Laser Scatter parameter. If cleaning is successful, the value should drop below 2.5V. Typical value for a clean optics chamber is around 0.7V and can range between 0.4 to 2.5V. Clean the chamber, click on the Start Flow button, and watch for the Laser Scatter parameter drop. If it does not decrease, contact TSI.</p>
Laser	Restart the unit first. If this does not correct the problem, contact TSI. If the Laser and System errors persist, please contact TSI since the laser may have failed and the unit may need to be returned to TSI for repair.
Filter	A filter error means that the filters should be replaced and the Reset Filter Date function on the Information screen needs to be executed.
Coincidence	The coincidence error indicates that the concentration is starting to exceed the limits of the instrument. The concentration will need to be lowered in order to get accurate sizing of the particle distribution.

Table C-1
 Troubleshooting Symptoms and Recommendations

Symptoms	Recommendations
<p>Flow blocked or stopped</p> <p>The pumps do not control the flows to the proper flow rates or the flows are erratic.</p>	<p>The Flow Blocked Stopped error indicates that sampling was stopped because of a persistent flow error.</p> <p>Check for blockage in the flow path:</p> <p>The outlet in the back panel may be blocked or covered. Check and clear any obstruction.</p> <p>The inner or outer nozzle may be dirty or clogged. See Chapter 6, "Maintenance."</p> <p>The filters may be clogged. See Chapter 6, "Maintenance."</p> <p>When using the instrument at pressures greater than 3"H₂O of pressure difference between the inlet and outlet of the instrument, TSI recommends that you plumb the exhaust back at the same pressure as the inlet. This will ensure that the sample flow and the sheath flow are maintained at the desired flow rates. You can also change the sample flow rate if the flow rate is off. The flow rate can be changed under Setup System Flow Calibration.</p>
<p>Instrument won't connect to the PC or laptop</p>	<p>It is likely that the instrument was connected and communicated with another PC. Without turning the instrument off and turning it back on, the instrument will not communicate with a different computer. Turn unit off and turn it back on and retry establishing communications.</p>
<p>No power.</p>	<p>If running on battery power, check that a battery is installed. Press the battery status button to see if the battery has any charge left.</p> <p>Check for good contact between the power cord and the external AC adapter.</p> <p>Check for power at the outlet.</p>
<p>Serial Communications not working.</p>	<p>See Table D-1, "Troubleshooting Serial Commands."</p>

Technical Contacts

- If you have any difficulty installing the Model 3330, or if you have technical or application questions about this instrument, contact an applications engineer at TSI Incorporated, (651) 490-2811 or contact particle@tsi.com.
- If the Model 3330 fails, or if you are returning it for service, visit our website at <http://rma.tsi.com> or contact TSI at:

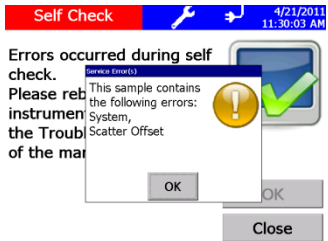
TSI Incorporated

500 Cardigan Road
Shoreview, MN 55126 USA

Phone: +1-800-874-2811 (USA) or +1 (651) 490-2811

E-mail: particle@tsi.com

TSI GmbH

Neuköllner Strasse 4
52068 Aachen
GERMANY

Telephone: +49 241-52303-0

Fax: +49 241-52303-49

E-mail: tsigmbh@tsi.com

Web: www.tsiinc.de

TSI Instruments Ltd.

Stirling Road
Cressex Business Park
High Wycombe, Bucks
HP12 3ST
UNITED KINGDOM

Telephone: +44 (0) 149 4 459200

Fax: +44 (0) 149 4 459700

E-mail: tsiuk@tsi.com

Web: www.tsiinc.co.uk

(This page intentionally left blank)

APPENDIX D

Using Serial Data Commands

This chapter contains information you need if you are writing your own software for a computer or data acquisition system. Information includes:

- Command definitions and syntax.
- Examples, as well as input and troubleshooting directions are also provided.

Communications

The Model 3330 communicates over a TCP/IP connection after opening a socket on port 3602:

- Using NDIS for a USB connection. (You will need the Aerosol Instrument Manager[®] software disk to load the PC with the NDIS drivers to communicate with the unit.)
- Directly for an Ethernet connection.
- Note that if the 3330 is connected to a PC over USB, the unit will need to be powered down and back up again in order to connect over USB to a different PC.

Commands

The Model 3330 OPS spectrometer uses an ASCII-based communications protocol to transmit commands in the form of strings over a TCP/IP connection on port 3602. NDIS for a USB connection; directly for an Ethernet connection.

Either the requested data or an "OK" is returned if the command is understood. The word "ERROR" or "FAIL" is returned if the command is not understood or if the command has an invalid parameter.

The following provides command definitions, syntax, and examples.

How to Input Commands and Troubleshoot the Results

Use the following information as a guide to input software commands and for troubleshooting problems.

Input Guidelines

- Input all alpha characters as UPPERCASE capital letters (SMZ, *not* smz).
- Separate parameters with commas, not spaces.
- If you are in a command string, use the <Backspace> key to back up and make changes. Do *not* use <arrow> keys.
- At the end of a command string, press <Enter> to complete the string.

Troubleshooting Input

Use Table D-1 as a troubleshooting guide.

Table D-1
Troubleshooting Serial Commands

Symptom	Possible Problem	Refer to
"Error" message after pressing <Enter>.	An invalid command; command does not exist. An invalid parameter, which includes too many parameters or a parameter that is out-of-range. Incorrect syntax	Figure D-2 in this appendix. The command showing the range and an example. "Input Guidelines" in this section.
No response after pressing <Enter>.	USB cable Incorrect IP address or port number. Model 3330 is locked up.	Check the USB cable and the cable connection. See Chapter 2, "Unpacking and System Setup." Input the correct IP address and port number look at GUI for IP address, and use port 3602. Remove power from the Model 3330, then apply power to the instrument. If the problem continues, contact TSI.

HyperTerminal Setup Example

Obtain the USB or Ethernet IP address from the GUI.

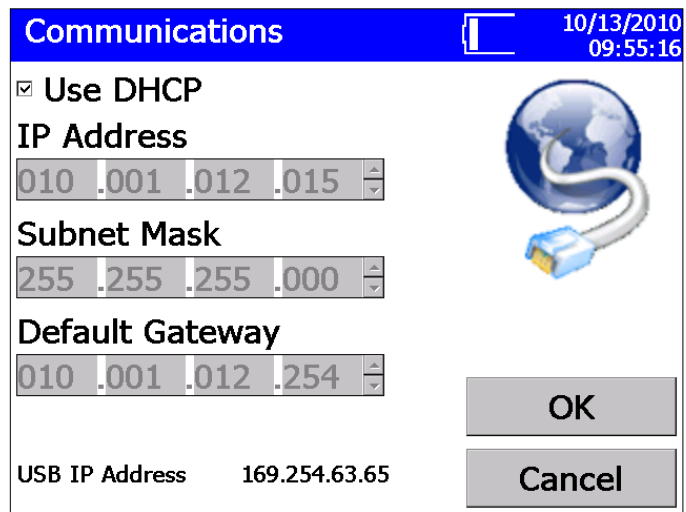

Figure D-1
Communications Screen—Use DHCP

Open HyperTerminal

Open a TCP/IP Connection.

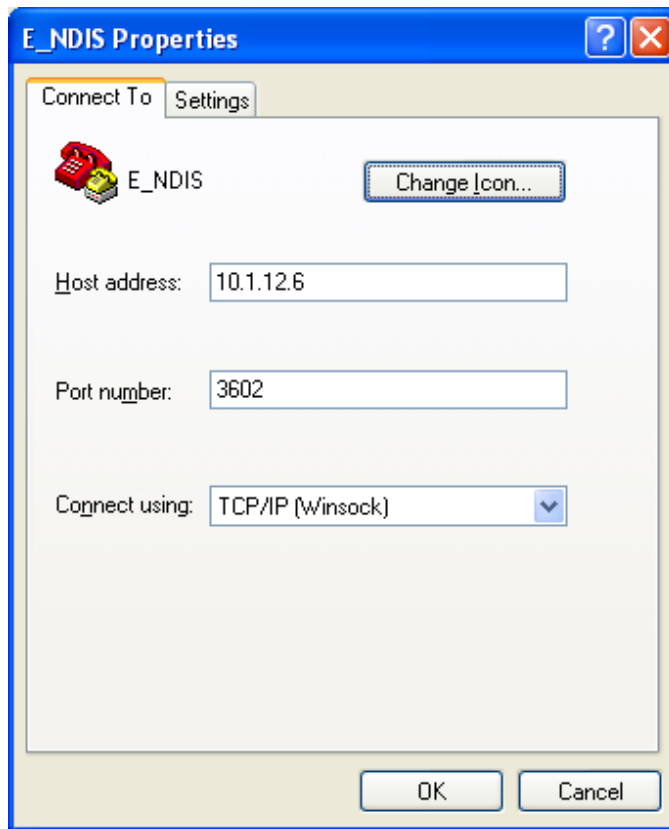

Figure D-2
E_NDIS Properties Screen

Reference

b => Boolean

i => integer

f => 32 bit float value

s => string

dC; Counts

dN; Number Concentration

dM; Mass Concentration

dN/dD; Number Concentration Linearly Normalized

dM/dD; Mass Concentration Linearly Normalized

dN/dLogD; Number Concentration Logarithmically Normalized

dM/dLogD; Mass Concentration Logarithmically Normalized

Code Examples

```
// "WMODEALARM b,b,b,b,f" is the command to write the alarm
//settings
// The command must be followed by a CR.

// Command
// buff = "WMODEALARM 1,0,0,1,4000.0"
// Sets Visible Alarm to be ON
// Audible & Relay are turned OFF
// The threshold units are set to Number Concentration
// The threshold is set to 4000 #/cm3

iRet = m_pSocket->Send( "WMODEALARM 1,0,0,1,4000.0\r",26);

// The returned value is a string containing status of the command
// (i.e. OK or FAIL)

iRet = m_pSocket->Receive( buff,PACKET_SIZE,0);
```

```
// "RMODEALARM" is the command to read the alarm settings
// The command must be followed by a CR.

// Command
// buff = "RMODEALARM"

iRet = m_pSocket->Send( "RMODEALARM\r",11);

iRet = m_pSocket->Receive( buff,PACKET_SIZE,0);
// Reply
// buff = "1,0,0,1,4000.0"
// Visible Alarm is ON
// Audible & Relay are OFF
// The threshold units are set to Number Concentration
// The threshold is set to 4000 #/cm3
```

Read Instrument Information

Read the Model Number of the Instrument

Command	RDMN
Return value	A string containing the model of the instrument.

Read the Serial Number of the Instrument

Command	RDSN
Return value	A string containing the serial number of the instrument.

Read the Firmware Version of the Instrument

Command	RDBS
Return value	A string containing the firmware version of the instrument.

Read the Bin Count Values in Real Time

Command	RMBINS
Return value	<p>A comma separated string containing the following data format in real time.</p> <p>Current Second in set, Current Second in Sample, Valid Sample in RMLOGGEDBINS (used for Aerosol Instrument Manager[®] software) <CR> Live Bin 1 dC, Live Bin 2 dC, Live Bin 3 dC, Live Bin 4 dC, ... Live Bin 13 dC, Live Bin 14 dC, Live Bin 15 dC, Live Bin 16 dC, Live Greater than Bin 16 dC,</p>

Read the Bin Count Value at End of Sample

Command	RMLOGGEDBINS
Return value	<p>A comma separated string containing the following data format in real time.</p> <p>Second sample was taken in set, Second sample was taken, Valid Sample in RMLOGGEDBINS (used for Aerosol Instrument Manager[®] software) <CR> Sampled Bin 1 dC, Sampled Bin 2 dC, Sampled Bin 3 dC, ... Sampled Bin 14 dC, Sampled Bin 15 dC, Sampled Bin 16 dC, Sampled Greater than Bin 16 dC,</p>

Read the Current Measurements of the Instrument in Real Time

Command	RMMEAS
Return value	<p>A comma separated string containing the following data format in real time.</p> <p>Current Second in set, Current Second in Sample, Valid Sample in RMLOGGEDBINS (used for Aerosol Instrument Manager[®] software) <CR></p> <p>Live Bin 1 dC, Live Bin 2 dC, Live Bin 3 dC, Live Bin 4 dC, ... Live Bin 13 dC, Live Bin 14 dC, Live Bin 15 dC, Live Bin 16 dC, Live Greater than Bin 16 dC, <CR></p> <p>Live Bin 1 dN, Live Bin 2 dN, Live Bin 3 dN, Live Bin 4 dN, ... Live Bin 13 dN, Live Bin 14 dN, Live Bin 15 dN, Live Bin 16 dN, Live Greater than Bin 16 dN, <CR></p> <p>Live Bin 1 dn/dD, Live Bin 2 dN/dD, Live Bin 3 dN/dD, ... Live Bin 14 dN/dD, Live Bin 15 dN/dD, Live Bin 16 dN/dD, Live Greater than Bin 16 dN/dD, <CR></p> <p>Live Bin 1 dn/dLogD, Live Bin 2 dN/dLogD, ... Live Bin 15 dN/dLogD, Live Bin 16 dN/dLogD, Live Greater than Bin 16 dN/dLogD, <CR></p> <p>Live Bin 1 dM, Live Bin 2 dM, Live Bin 3 dM, Live Bin 4 dM, ... Live Bin 13 dM, Live Bin 14 dM, Live Bin 15 dM, Live Bin 16 dM, Live Greater than Bin 16 dM, <CR></p> <p>Live Bin 1 dM/dD, Live Bin 2 dM/dD, Live Bin 3 dM/dD, ... Live Bin 14 dM/dD, Live Bin 15 dM/dD, Live Bin 16 dM/dD, Live Greater than Bin 16 dM/dD, <CR></p> <p>Live Bin 1 dM/dLogD, Live Bin 2 dM/dLogD, ... Live Bin 15 dM/dLogD, Live Bin 16 dM/dLogD, Live Greater than Bin 16 dM/dLogD, <CR></p> <p>Live Total dC, Live Total dN, Live Total dM</p>

The Measurement Value at End of Sample

Command	RMLOGGEDMEAS
Return value	<p>The measurement value at the end of the sample.</p> <p>Second sample was taken in set, Second sample was taken,</p> <p>Valid Sample in RMLOGGEDBINS (used for Aerosol Instrument Manager[®] software) <CR></p> <p>Sampled Bin 1 dC, Sampled Bin 2 dC, Sampled Bin 3 dC,</p> <p>...</p> <p>Sampled Bin 14 dC, Sampled Bin 15 dC, Sampled Bin 16 dC, Sampled Greater than Bin 16 dC, <CR></p> <p>Sampled Bin 1 dN, Sampled Bin 2 dN, Sampled Bin 3 dN,</p> <p>...</p> <p>Sampled Bin 14 dN, Sampled Bin 15 dN, Sampled Bin 16 dN, Sampled Greater than Bin 16 dN, <CR></p> <p>Sampled Bin 1 dn/dD, Sampled Bin 2 dN/dD,</p> <p>...</p> <p>Sampled Bin 15 dN/dD, Sampled Bin 16 dN/dD, Sampled Greater than Bin 16 dN/dD, <CR></p> <p>Sampled Bin 1 dn/dLogD, Sampled Bin 2 dN/dLogD,</p> <p>...</p> <p>Sampled Bin 15 dN/dLogD, Sampled Bin 16 dN/dLogD, Sampled Greater than Bin 16 dN/dLogD, <CR></p> <p>Sampled Bin 1 dM, Sampled Bin 2 dM, Sampled Bin 3 dM,</p> <p>...</p> <p>Sampled Bin 14 dM, Sampled Bin 15 dM, Sampled Bin 16 dM, Sampled Greater than Bin 16 dM, <CR></p> <p>Sampled Bin 1 dM/dD, Sampled Bin 2 dM/dD,</p> <p>...</p> <p>Sampled Bin 15 dM/dD, Sampled Bin 16 dM/dD, Sampled Greater than Bin 16 dM/dD, <CR></p> <p>Sampled Bin 1 dM/dLogD, Sampled Bin 2 dM/dLogD,</p> <p>...</p> <p>Sampled Bin 15 dM/dLogD, Sampled Bin 16 dM/dLogD, Sampled Greater than Bin 16 dM/dLogD, <CR></p> <p>Sampled Total dC, Sampled Total dN, Sampled Total dM</p>

Read Raw Bin Data at End of Sample

Command	RMRAWBINS
Return value	<p>A comma separated string containing the following data format in real time.</p> <p>Sampled Bin 1 dC, Sampled Bin 2 dC, Sample Bin 3 dC, ... Sampled Bin 2046 dC, Sampled Bin 2047 dC, Sample Bin 2048 dC,</p>

Read Some Unit Measurements of the Instrument

Command	RMUNITMEAS
Return value	<p>A comma separated string containing the following data.</p> <p>Total Volumetric Flow (lpm), Sheath Volumetric Flow (lpm), Laser Current (mA), Laser scatter (V), Flow Temp (C), Unit Temp (C), Humidity (%), Ambient Pressure (kPA).</p> <p>Note: The Humidity (%) is currently only a placeholder for future upgrades. Hence, humidity will be displayed as 0.0 all the time and does not represent the actual humidity of the sampling air.</p>

Read the Fault Messages of the Instrument

Command	RMMESSAGES
Return value	<p>A comma separated string containing the following integer data format based on the instrument model.</p> <p>MSTATUS, System Error, Measurement Alarmed, Buzzer Alarmed, Laser Error, Flow Error, Flow Blocked, Flow Blocked Stop Error, Coincidence Error, Filter Concentration Warning, Battery Installed, Battery Charging, Battery Percentage, Battery Low Error, AC Plugged In, Memory Percentage, Memory Low Error.</p>

Read the State of Data Logging

Command	RMLOGINFO
Return value	<p>A comma separated string containing the following data format.</p> <p>Log Error, Set Name, Total Time (sec), Time Elapsed (sec), Time Remaining (sec), Current Test, Total Tests.</p> <p>Possible Log Errors:</p> <ul style="list-style-type: none">0: IDLE / no errors1: Running2: Number of Tests exceeds max limit3: Start Time / Date has or is going to elapse4: Number of Samples exceeds max limit5: Sample Interval out of Range6: Repeat Interval too Short7: Unable to repeat forever and log

Database Memory Information

Command	RMMEMORY
Return value	Returns number of test and samples used and max available.

Returns Who Has the System Locked

Command	RMCONTROL
Return value	<p>system which has the unit locked</p> <p>Possible results:</p> <ul style="list-style-type: none">OPENGUINDIS12 character string

Read Ethernet IP Address

Command	IPADD
Return value	A string containing the Ethernet IP address, subnet mask, and gateway of the instrument.

Set Up the Instrument

Note: *MUPDATE* command must be sent before any Write command will take effect.

Read Logging Mode Set Up Data

Command	RMODELOG
Return value	<p>A comma separated string containing the following data format.</p> <p>Start Time, Start Date, Sample Interval, Number of Samples, Number of Sets, Repeat Interval, Use Start Time, Use Start Date, Logging Enabled, Log to Single File, Survey Mode, Keep Pump Running.</p> <p>Return value formats:</p> <p>Start Time: Hour:Minute Start Date: Month/Day/Year Sample Interval: Hour:Minute:Second Number of Samples: Integer Num. of Sets: Integer, 0 = repeat forever Repeat Interval: Day:Hour:Minute Use Start Time 1 enabled, 0 disabled Use Start Date 1 enabled, 0 disabled Logging Enabled 1 enabled, 0 disabled Log to Single File 1 enabled, 0 disabled Survey Mode 1 enabled, 0 disabled Keep Pump Running 1 enabled, 0 disabled</p>

Write Logging Mode Set Up Data

Command	WMODELOG i:i,i/i/i,i:i:i,i,i,i:i:i,b,b,b,b,b,b
Return value	<p>A string response OK indicating that the command was accepted, or descriptive error sting indicating the value which is out of range.</p> <p>INPUT Arguments: WMODELOG Start Time, Start Date, Sample Interval, Number of Samples, Number of Sets, Repeat Interval, Use Start Time, Use Start Date, Logging Enabled, Log to Single File, Survey Mode, Keep Pump Running.</p> <p>Input value formats:</p> <p>Start Time: Hour:Minute Start Date: Month/Day/Year Sample Interval: Hour:Minute:Second (1 – 86400 sec)</p> <p>Number of Samples: Integer Num. of Sets: Integer (0 = repeat forever) Repeat Interval: Day:Hour:Minute (1 –144000 min)</p> <p>Use Start Time 1 enabled, 0 disabled Use Start Date 1 enabled, 0 disabled Logging Enabled 1 enabled, 0 disabled Log to Single File 1 enabled, 0 disabled Survey Mode 1 enabled, 0 disabled Keep Pump Running 1 enabled, 0 disabled</p>

Read Alarm Set Up Data

Command	RMODEALARM
Return value	<p>A comma separated string containing the following data format.</p> <p>Visible Alarm enabled, Audible Alarm enabled, Relay Alarm enabled, Measurement, Alarm Threshold value.</p> <p>Return value formats:</p> <p>Visible Alarm enabled 1 enabled, 0 disabled Audible Alarm enabled 1 enabled, 0 disabled Relay Alarm enabled 1 enabled, 0 disabled Measurement 1 dN, 0 dM Alarm Threshold value float</p>

Write Alarm Set Up Data

Command	WMODEALARM b,b,b,b,f										
Return value	<p>A string response OK indicating that the command was accepted, or FAIL indicating the command was not accepted (a value was out of range).</p> <p>INPUT Arguments: WMODEALARM Visible Alarm enabled, Audible Alarm enabled, Relay Alarm enabled, Measurement, Alarm Threshold value.</p> <p>Input value formats:</p> <table> <tr> <td>Visible Alarm enabled</td> <td>1 enabled, 0 disabled</td> </tr> <tr> <td>Audible Alarm enabled</td> <td>1 enabled, 0 disabled</td> </tr> <tr> <td>Relay Alarm enabled</td> <td>1 enabled, 0 disabled</td> </tr> <tr> <td>Measurement</td> <td>1 total dN, 0 total dM</td> </tr> <tr> <td>Alarm Threshold value</td> <td>float value from 0 - 10000 dN or 2e8 dM</td> </tr> </table>	Visible Alarm enabled	1 enabled, 0 disabled	Audible Alarm enabled	1 enabled, 0 disabled	Relay Alarm enabled	1 enabled, 0 disabled	Measurement	1 total dN, 0 total dM	Alarm Threshold value	float value from 0 - 10000 dN or 2e8 dM
Visible Alarm enabled	1 enabled, 0 disabled										
Audible Alarm enabled	1 enabled, 0 disabled										
Relay Alarm enabled	1 enabled, 0 disabled										
Measurement	1 total dN, 0 total dM										
Alarm Threshold value	float value from 0 - 10000 dN or 2e8 dM										

Read Channel Set Up Data

Command	RMODECHSETUP
Return value	<p>A comma separated string containing the following data format.</p> <p>Return Values:</p> <p>Number channels enabled, Bin 1 Lower cut point, Bin 2 Lower cut point, ... Bin 15 Lower cut point, Bin 16 Lower cut point, Bin 16 Upper cut point</p>

Write Channel Set Up Data

Command	WMODECHSETUP i,f,f,f,f,f,f,f,f,f,f,f,f,f,f,f,f
Return value	<p>A string response OK indicating that the command was accepted, or FAIL indicating the command was not accepted (a value was out of range).</p> <p>INPUT Arguments: WMODECHSETUP Number channels enabled, Bin 1 Lower cut point, Bin 2 Lower cut point, ... Bin 15 Lower cut point, Bin 16 Lower cut point, Bin 16 Upper cut point</p> <p>Possible Input Values:</p> <p>Number channels enabled = 1 – 16 Bins must be between 0.3 – 10.0, and are restricted to a minimum width of approximately 5% of the lower cut point.</p>

Read Analog Out Set Up Data

Command	RMODEANALOG
Return value	<p>A comma separated string containing the following data format.</p> <p>State, Measurement, Minimum Value, Maximum Value</p> <p>Possible Return Values:</p> <p>State OFF=0, 1=0-5V, 2=4-20mA</p> <p>Measurement 1= Total dN, 0= Total dM</p> <p>Minimum Value float 0 10000dN or 2e8 dM</p> <p>Maximum Value float 0 10000dN or 2e8 dM</p>

Write Analog Output Set Up Data

Command	WMODEANALOG i,b,f,f
Return value	<p>A string response OK indicating that the command was accepted, or FAIL indicating the command was not accepted (a value was out of range).</p> <p>INPUT Arguments: WMODEANALOG State, Measurement, Minimum Value, Maximum Value.</p> <p>Possible Input Values:</p> <p>State OFF=0, 1=0-5V, 2=4-20mA</p> <p>Measurement 1= Total dN, 0= Total dM</p> <p>Minimum Value float 0 – Maximum Value</p> <p>Maximum Value float Minimum Value - 10000dN or 2e8 dM</p>

Read User Calibration Set Up Data

Command	RMODEUSERCAL
Return value	<p>A comma separated string containing the following data format.</p> <p>User Cal enabled, Dead time Correction enabled, Density, Refractive Index Real, Refractive Index Imaginary, Shape Correction Factor.</p> <p>Possible Return Values:</p> <p>User Cal enabled 0 = disabled, 1 = enabled</p> <p>Dead time Correction enabled 0 = disabled, 1 = enabled</p> <p>Density float 0.0 – 15.0</p> <p>Refractive Index Real float 1.1 – 6.0</p> <p>Refractive Index Imaginary float 0.0 – 6.0</p> <p>Shape Correction Factor float 0.1 – 3.0</p>

Write User Calibration Set Up Data

Command	WMODEUSERCAL b,b,f,f,f												
Return value	<p>A string response OK indicating that the command was accepted, or FAIL indicating the command was not accepted (a value was out of range).</p> <p>INPUT Arguments: WMODEUSERCAL User Cal enabled, Dead time Correction enabled, Density, Refractive Index Real, Refractive Index Imaginary, Shape Correction Factor.</p> <p>Possible Input Values:</p> <table> <tr> <td>User Cal enabled</td> <td>0 = disabled, 1 = enabled</td> </tr> <tr> <td>Dead time Correction enabled</td> <td>0 = disabled, 1 = enabled</td> </tr> <tr> <td>Density</td> <td>float 0.0 – 15.0</td> </tr> <tr> <td>Refractive Index Real</td> <td>float 1.1 – 6.0</td> </tr> <tr> <td>Refractive Index Imaginary</td> <td>float 0.0 – 6.0</td> </tr> <tr> <td>Shape Correction Factor</td> <td>float 0.1 – 3.0</td> </tr> </table>	User Cal enabled	0 = disabled, 1 = enabled	Dead time Correction enabled	0 = disabled, 1 = enabled	Density	float 0.0 – 15.0	Refractive Index Real	float 1.1 – 6.0	Refractive Index Imaginary	float 0.0 – 6.0	Shape Correction Factor	float 0.1 – 3.0
User Cal enabled	0 = disabled, 1 = enabled												
Dead time Correction enabled	0 = disabled, 1 = enabled												
Density	float 0.0 – 15.0												
Refractive Index Real	float 1.1 – 6.0												
Refractive Index Imaginary	float 0.0 – 6.0												
Shape Correction Factor	float 0.1 – 3.0												

Read User Flow Calibration Set Up Data

Command	RMODEFLOWCAL				
Return value	<p>a comma separated string containing the following data format.</p> <p>User Flow Cal, External Flow Control Enabled.</p> <p>Possible Return Values:</p> <table> <tr> <td>User Flow Cal</td> <td>float 0.8 - 1.2</td> </tr> <tr> <td>External Flow Control Enabled</td> <td>0 = disabled. This value will always be 0, not currently supported</td> </tr> </table>	User Flow Cal	float 0.8 - 1.2	External Flow Control Enabled	0 = disabled. This value will always be 0, not currently supported
User Flow Cal	float 0.8 - 1.2				
External Flow Control Enabled	0 = disabled. This value will always be 0, not currently supported				

Write User Flow Calibration

Command	WMODEFLOWCAL f,b
Return value	<p>A string response OK indicating that the command was accepted, or FAIL indicating the command was not accepted (a value was out of range).</p> <p>INPUT Arguments: WMODEFLOWCALIBRATION User Flow Cal, External Flow Control Enabled</p> <p>Possible Input Values:</p> <p>User Flow Cal float 0.8 - 1.2</p> <p>External Flow Control Enabled 0 = disabled. This value will always be 0, not currently supported</p>

Read the Setting from a Specified Protocol

Command	RMODEPROTOCOL I (where i is the protocol to view)
Return value	<p>A comma separated string containing the following data format.</p> <p>INPUT Arguments: RMODEPROTOCOL i, i = 1 - 16</p> <p>Protocol Name, RMODELOG <CR> RMODECHSETUP <CR> RMODEALARM <CR> RMODEANALOG <CR> RMODEUSERCAL <CR> RMODEFLOWCAL</p>

Write Current Register Contents as a Protocol with names

Command	WMODEPROTOCOL s
Return value	<p>A string response OK indicating that the command was accepted, or FAIL indicating the command was not accepted (a value was out of range).</p> <p>INPUT Arguments: WMODEPROTOCOL s : Protocol string name to apply to the current configuration. s is limited to 12 characters.</p>

Read Currently Selected Protocol Out of Total Saved Protocol

Command	RMODECURPROTOCOL
Return value	a comma separated string containing the following data format. Currently selected Protocol (0 = none selected), Total number of saved Protocols.

Select a Saved Protocol

Command	WMODECURPROTOCOL i
Return value	A string response OK indicating that the command was accepted, or FAIL indicating the command was not accepted (a value was out of range). INPUT Arguments: WMODECURPTOTOCL i : Protocol to select 1 – 16.

Read the Names and Dates of 10 Protocols Starting at

Command	RMODENAMESPROTOCOL i
Return value	A comma separated string containing the following data format. Starting at protocol i → i + 10 Protocol Name, Protocol Start Date m/d/y, Protocol Start Time h:m:s, Repeat 9 more times with a new line for each entry.

Delete a Protocol

Command	WMODEDELETEPROTOCOL i
Return value	A string response OK indicating that the command was accepted, or FAIL indicating the command was not accepted (a value was out of range). INPUT Arguments: WMODEDELETEPRTOCOL i : Protocol to delete. 7 – 16.

Read IP Mode and Address and Submask

Command	RMODEIP
Return value	A comma separated string containing the following data format. Static / dynamic, IP Address, Subnet Mask, Gateway Static = 1, Dynamic = 0

Write IP Mode and Address and Submask

Command	WMODEIP i.i.i,i.i.i,i.i.i
Return value	<p>A string response OK indicating that the command was accepted, or FAIL indicating the command was not accepted (a value was out of range).</p> <p>INPUT Arguments: WMODEIP Static / dynamic, IP Address, Subnet Mask, Gateway Static = 1, Dynamic = 0 All other numbers are 0 - 255</p>

Read the Date and Time

Command	IPADD
Return value	<p>A string containing the Ethernet IP address, subnet mask, and gateway of the instrument.</p> <p>Command: RSDATETIME Return value: a comma separated string containing the following:</p> <p>Month/Day/Year,Hour:Minute:Second. Month -> 1 – 12 Day -> 1 – 31 Year -> 1975 – 2100 Hour -> 0 – 23 Minute -> 0 – 59 Second -> 0 - 59</p>

Write the Date and Time

Command	WSDATETIME i/i,i:i:i
Return value	<p>A string response OK indicating that the command was accepted, or FAIL indicating the command was not accepted (a value was out of range).</p> <p>INPUT Arguments: WSDATETIME Month/Day/Year,Hour:Minute:Second. Month -> 1 – 12 Day -> 1 – 31 Year -> 1975 - 2100 Hour -> 0 – 23 Minute -> 0 – 59 Second -> 0 – 59</p>

Read the Calibration Date

Command	RSCALDATE
Return value	A comma separated string containing the following data format. Calibration Day/Month/Year, Run time since last calibration in hours, Pump run time in hours.

Read the Filter Change Date and Set Run Time to 0

Command	RSFILTERCHANGEDATE
Return value	A comma separated string containing the following data format. Filter change Day/Month/Year.

Write the Filter Change Date

Command	WSFILTERCHANGEDATE
Return value	A string response OK indicating that the command was accepted, or FAIL indicating the command was not accepted (a value was out of range). The current date set on the instrument will be used as the filter change date.

Place Instrument into a new State

Update Ram Values with Registry

Command	MUPDATE
Return value	A string response OK indicating that the instrument RAM was updated, or FAIL indicating an error during the RAM update. This command needs to be done after any "W..." command in order for the command to take effect.

Read the Current User Polling Status of the Instrument

Command	MSTATUS
Return value	A string containing the user polling status of the instrument.
Responses	SYSTEM ERROR Log Error Updating Idle Starting Waiting for pump or log time Ready Running Deleting USB Memory Stick Error Booting Saving Error

Start the Instrument Measurement

Command	MSTART
Return value	A response OK indicating that the instrument started, or FAIL indicating an error starting the measurement.

Stop the Instrument Measurement

Command	MSTOP
Return value	A string response OK indicating that the instrument is stopping, or FAIL indicating an error stopping the measurement.

Start Everything in the Instrument Except Particle Counting

Command	MSTARTPUMP
Return value	A response OK indicating that the instrument started and is ready to sample data, or FAIL indicating an error starting the instrument.

Stop Counting Particles, but Keep Everything Else Running

Command	MSTOPBIN
Return value	A response OK indicating that the instrument will stop sampling, but keep the pumps running, or FAIL indicating an error stopping the instrument.

Start to Count Particles

Command	MBIN
Return value	A response OK indicating that the instrument is starting to sample data, or FAIL indicating an error starting to sample the data the instrument.

Turn Off the Buzzer

Command	MBUZZEROFF
Return value	A response OK indicating that the instrument will shut off the buzzer while the current alarm is active and until the next alarm becomes active, or FAIL indicating an error shutting off the buzzer.

Lock the System

Command	MLOCK
Return value	<p>A response OK indicating that the instrument GUI locked and only the connected PC will be able to control the unit (unless the override command is initiated), or FAIL indicating an error locking the instrument.</p> <p>MLOCK s – where s is a 12 character string to indicate who is locking the unit.</p>

Unlock the System

Command	MUNLOCK
Return value	<p>A response OK indicating that the instrument unlocked, or FAIL indicating an error unlocking the instrument.</p> <p>If the unit is locked by GUI or another program in order to unlock the unit the RMCONTROL command needs to be sent and then the MUNLOCK command.</p>

Shutdown the Instrument

Command	MSHUTDOWN
Return value	A string response OK indicating that the instrument is shutting down, or FAIL indicating an error shutting down the instrument.

(This page intentionally left blank)

Index

2

24 hour, 4-13

A

about this manual, xiii
AC adapter, 2-3, 2-4
accessories, A-2
advisory labels, vi
Aerosol Instrument Manager Software manual, xiii
alarm
 wiring, 2-7
alarm icon, 4-34
alarm out, A-2
alarm out connection, 2-7
alarm threshold, 4-34
alarms screen, 4-34
analog out, A-1
analog out screen, 4-11
analog output
 wiring, 2-6
analog/alarm cable, 2-6
analog/alarm output, 3-3
analog/alarm output cable, 2-2
applications, 1-2

B

background light, 4-19
battery
 charging, 2-5
battery installation, 2-4
battery label, vi
blue retention clip, 6-4

C

calibrating flow, 4-9
calibration, 6-6, A-2
calibration certificate, 2-2
calibration frequency, A-2
carrying case, 2-1
caution
 attaching inlet and positive pressure, 3-1, 4-1, 5-3
caution symbols, vii
CD-ROM, 2-1
CE rating, A-2
channels screen, 4-22
charging battery, 2-5
checking filter holder, 6-5
Class 1 laser, v
cleaning inner nozzle, 6-2
clear data, 4-7

code examples, D-5
coincidence, C-1
commands, D-1
 inputting, D-2
communications, A-1
communications connections, 3-2
communications screen, 4-14, D-3
computer, connecting, 2-5
concentration calculations, 5-4
conductive tubing, 2-2
connecting computer, 2-5
contamination error, C-1
continous mode
 pump life, 4-9
csv file, B-1

D

data logging, A-1
data setup screen, 4-7
data tab, 4-36
data tab screen, 4-36
database memory information, D-10
date, 4-13
date and time setup, 4-13
date format, 4-13
dead time, 5-5
dead time correction, 4-24
default gateway, 4-14
delete a protocol, D-17
delete data screen, 4-38
density, 4-24
description, 1-1
description of OPS, 3-1
device setup screen, 4-12
DHCP, 4-14
diagnostic screen, 4-17
diagnostics screen, 4-17
 pump on, 4-18
DIN connector, 2-6
display, A-1
display screen, 4-15

E

E_NDIS properties screen, D-4
edit channel dialog, 4-22
edit channel dialog screen, 4-22
electrical shock caution, vi
enable, 4-11
enable logging, 4-32
Ethernet connection, 3-3
exhaust port, 3-4

F

filter, C-1
filter cassette, 6-4, 6-5, 6-6
filter label, vi
filter media, 6-6
filter opening tool, 2-3
filter removal tool, 2-2
flow accuracy, A-1
flow alarm, A-2
flow blocked, C-2
flow calibration, 4-9
flow calibration screen, 4-9, 4-10
flow path sample, 5-2
flow rate, A-1
flow source, A-2
front panel, 3-1

G

gravimetric sampling, A-2

H

HyperTerminal setup example, D-3

I-J

I/O port, 2-6
Icons, 4-4
identification labels, vi
index of refraction, 4-23, 4-24
information screen, 4-16
inlet nozzle, 3-2, 6-2
input commands, D-2
input guidelines, D-2
installing batteries, 2-4
instrument state icons, 4-5, 4-6
instrument won't connect to PC or laptop, C-2
internal filter
 replacing, 6-2
internal filter
 replacing, 6-3
internal filter element, 2-3
IP address, 4-14

K

keep pump on, 4-9, 4-10, 4-17, 4-18, 5-3
keyboard, on screen, 4-3

L

laser, C-1
laser instrument compliance label, vi
laser radiation label, vi

LCD display, 3-2
light source, A-2
lock the system, D-21
log interval, A-1

M

main tab, 4-2, 4-4
main tab screen, 4-2
maintenance, 6-1
 calibration, 6-6
 cleaning inner nozzle, 6-2
 schedule, 6-1
maintenance schedule, 6-2
manual history, ii
measurement value at end of
 sample, D-8
Model 3332 Dilution System, xiii
Model 8535 Environmental
 Enclosure, xiii

N

no power, C-2
number of samples, 4-32
number of sets, 4-33

O

on/off button, 3-2
on-screen keyboard, 4-3
open HyperTerminal, D-4
opening filter using supplied tool, 6-5
operation, 1-3, 4-1
operational humidity, A-1
operational temp, A-1
OPS. (see *Optical Particle Sizer spectrometer*)
Optical Particle Sizer
 spectrometer, 1-2
 applications, 1-2
 calibration, 6-6
 Class I laser, v
 connecting computer, 2-5
 description, 1-1, 3-1
 front panel, 3-1
 I/O port, 2-6
 inputting commands, D-2
 maintenance, 6-1
 operation, 4-1
 overview, 1-1
 packing list, 2-1
 safety, v
 serial data commands, D-1
 serial port connector, 2-5
 setting up, 2-1
 theory of operation, 5-1
 troubleshooting, C-1
 unpacking, 2-1
 ventilation requirements, 2-3
optics path, 5-4
overview, 1-1

P–Q

packing list, 2-1

particle size range, A-1
physical size, A-1
pin connectors, D-1
positive pressure, A-2
 caution, 3-1, 4-1, 5-3
power connector, 3-2, 3-3
power, DC, A-1
printing, 2-6
product registration, ii
protocol screen, 4-35
protocol testP screen, 4-36
pulling out single cylindrical filter from
 filter well, 6-4

R

range, 4-11
read alarm set up data, D-12
read analog out set up data, D-14
read bin count value at end of
 sample, D-6
read bin count values in real time, D-6
read calibration date, D-19
read channel set up data, D-13
read current measurements in real
 time, D-7
read current user polling status of
 instrument, D-20
read currently selected protocol out of
 total saved protocol, D-17
read date and time, D-18
read Ethernet IP address, D-10
read fault messages, D-9
read filter change date and set run
 time to 0, D-19
read firmware version, D-6
read instrument information, D-5
read IP mode and address and
 submask, D-17
read logging mode set up data, D-11
read model number, D-5
read names and dates of 10 protocols
 starting at #, D-17
read raw bin data at end of
 sample, D-9
read serial number, D-5
read setting from specified
 protocol, D-16
read some unit measurements, D-9
read state of data logging, D-10
read user calibration set up data, D-14
read user flow calibration set up
 data, D-15
rechargeable battery, 2-2
reference, D-4
repeat forever, 4-33
repeat interval, 4-33
replacing internal filter, 6-3
reset protocol list, 4-8
reset the touchscreen alignment, 4-15
returns who has the system
 locked, D-10
reusing and recycling, viii

S

safety, v
safety certification validation, v
sample flow path, 5-2
sample length, 4-32
sampling modes, A-2
sampling setup screen, 4-21
save all data to a single data set, 4-33
save data, 4-7
save data screen, 4-37
scheduling details, 4-27
scheduling details screen, 4-28, 4-29,
 4-30, 4-31, 4-32
scheduling modes, 4-25
scheduling screen, 4-25
screen, A-2
select saved protocol, D-17
self check, 4-18, 4-20
 with or without zero filter, 4-19
self check button, 4-17, 4-18
self check screen, 4-18, 4-19
 error message, 4-20
 error message details, 4-20
serial communications not
 working, C-2
serial data commands, D-1
 commands, D-1
 pin connectors, D-1
serial number label, vi
serial port connector, 2-5
service policy, iv
set up instrument, D-11
setting up, 2-1, 2-4
setup tab, 4-6
setup tab screen, 4-6
sheath flow technology, 3-1, 4-1, 5-3
shutdown the instrument, D-21
size channel configurations, A-1
size channels, A-1
size resolution, A-1
software, A-2
spanner driver, 2-2
splash screen, 4-2
start date, 4-32
start everything in instrument except
 particle counting, D-20
start flow, 4-18
start flow button, 4-17
start instrument measurement, D-20
start to count particles, D-21
status indicators, A-2
stop counting particles, D-20
stop flow button, 4-17
stop instrument measurement, D-20
storage precautions, 6-6
storage temp, A-1
stylus, 2-3, 3-2
submitting comments, xiii
subnet mask, 4-14
supplying power, 2-4
survey mode, 4-32
system error, C-1

system setup screen, 4-8
system, scatter error, C-1

T

technical contacts, C-3
theory of operation, 5-1
threshold units, 4-34
threshold value, 4-34
time, 4-13
time constant, A-1
total set time, 4-33
touchscreen, 1-1
trademarks, iv
troubleshoot results, D-2
troubleshooting, C-1
 symptoms and recommendations,
 C-1
troubleshooting input, D-2
troubleshooting serial commands, D-2
turn off buzzer, D-21
type, 4-11
type of alarm, 4-34

U

unit ID, A-2
units, 4-11
unlock the system, D-21
unpacking, 2-1
update ram values with registry, D-19
USB cable, 2-2
USB device, 3-3
USB host, 3-3
USB IP address, 4-14
use DHCP, 4-14
user calibration screen, 4-24

V

ventilation requirements, 2-3
view data files, 4-39
view data screen, 4-39

W-X-Y

warning, v
 safety certification validation, v
warning symbols, vii
warranty, iii, A-2
weight, A-1
wiring alarm, 2-7
wiring analog output, 2-6
wrench symbol, 4-20
write alarm set up data, D-13
write analog output set up data, D-14
write channel set up data, D-13
write current register contents as
 protocol with names, D-16
write date and time, D-18
write filter change date, D-19
write IP mode and address and
 submask, D-18
write logging mode set up data, D-12
write user calibration set up
 data, D-15

write user flow calibration, D-16

Z

zero count, A-1
zero filter, 2-1

Reader's Comments

Please help us improve our manuals by completing and returning this questionnaire to the address listed in the "About This Manual" chapter. Feel free to attach a separate sheet of comments.

Manual Title Model 3330 Optical Particle Sizer[®] Spectrometer **P/N** 6004403

1. Was the manual easy to understand and use?

Yes No

1. Please identify any problem area(s) _____

2. Was there any incorrect or missing information? (please explain) _____

3. Please rate the manual according to the following features:

	Good	Adequate	Poor
Readability	<input type="checkbox"/>	<input type="checkbox"/>	<input type="checkbox"/>
Accuracy	<input type="checkbox"/>	<input type="checkbox"/>	<input type="checkbox"/>
Completeness (is everything there?)	<input type="checkbox"/>	<input type="checkbox"/>	<input type="checkbox"/>
Organization (finding what you need)	<input type="checkbox"/>	<input type="checkbox"/>	<input type="checkbox"/>
Quality and number of illustrations	<input type="checkbox"/>	<input type="checkbox"/>	<input type="checkbox"/>
Quality and number of examples	<input type="checkbox"/>	<input type="checkbox"/>	<input type="checkbox"/>

Comments: _____

4. Which part(s) of this manual did you find most helpful? _____

5. Rate your level of experience with the product:

Beginning Intermediate Expert

6. Please provide us with the following information:

Name _____ Address _____

Title _____

Company _____



UNDERSTANDING, ACCELERATED

TSI Incorporated – Visit our website www.tsi.com for more information.

USA	Tel: +1 800 874 2811	India	Tel: +91 80 67877200
UK	Tel: +44 149 4 459200	China	Tel: +86 10 8219 7688
France	Tel: +33 4 91 11 87 64	Singapore	Tel: +65 6595 6388
Germany	Tel: +49 241 523030		